



Altivar Soft Starter ATS490

Soft starters for
process and infrastructure
from 4 to 900 kW/3 to 1,200 HP

Quick access to product information

Get technical information about your product



Each commercial reference presented in a catalog contains a hyperlink. Click on it to obtain the technical information of the product:

- Characteristics, Dimensions and drawings, Mounting and clearance, Connections and schemas, Performance curves
- Product image, Instruction sheet, User guide, Product certifications, End of life manual



Find your catalog



- > With just 3 clicks, you can access the Industrial Automation and Control catalogs, in both English and French
- > Consult digital automation catalogs at [Digi-Cat Online](#)



- Up-to-date catalogs
- Embedded product selectors, 360° pictures
- Optimized search by commercial references

Select your training



- > Find the right [Training](#) for your needs on our Global website
- > Locate the training center with the selector tool, using this [link](#)



Life Is On

Schneider
Electric

mySchneider, your personalized digital experience

Access an all-in-one customized online experience and benefit from tailored business services, resources, and tools to efficiently support your business operations.

- **Efficiency:** In just a few clicks, find all the information and support you need to get the job done.
- **Simplicity:** Use a single login to access all business services, in one place, available 24/7. You no longer need to log in to multiple platforms.
- **Personalization:** Benefit from content, tools, and business services tailored to your activity, and customize your landing page based on your preferences.

Watch the How-to Videos



Order management

- > [Select Products and Add to Cart](#)
- > [Check for Products' Price and Availability](#)
- > [Order Products with Generic Commercial References](#)



Product information

- > [Find a Product Data Sheet and Related Documents](#)
- > [Select Products and Add to Cart](#)
- > [Stay Up to Date on the Status of My Products](#)



Support

- > [Get Quicker Answers Thanks to Online Support](#)



Training

- > [Access Trainings Dedicated to My Activity](#)

[Create your account](#)

Life Is On

Schneider
Electric



Digital tools to quickly select your soft starter solution

Product selector for ATS490

- Easy selection of the ATS490 commercial reference
- Expand it with options and accessories
- Get the Bill of Material in standard format
- Drop it into the product cart
- Access technical information and documentation

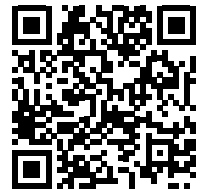

[Scan or click on the QR code](#)

EcoStruxure™ Motor Control Configurator

- From your application, select your soft starter reference
- Expand it with coordinated combination, options, and accessories
- Convert into Bill of Material, add the product to the cart
- Directly access product documentation
- Save, rework, share your solution with unique ID

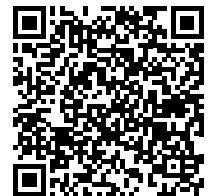

[Scan or click on the QR code](#)

EcoStruxure™ Motor Management Design

- From your project, perform electrical design calculation
- Compare direct-on-line, soft starter, and variable speed drive
- Verify starting feasibility from mechanical standpoint
- Verify that power factor and harmonics levels objectives are met
- Build a complete Motor Management solution: circuit breakers, soft starters, drives, contactors, MCC panels, power quality monitoring
- Get a summary report with calculations and recommended offers



[Scan or click on the QR code](#)



Altivar

Discover [Altivar](#)

Variable speed drives and soft starters

Improve your energy efficiency and sustainability with Altivar variable speed drives and soft starters. Manage motor control applications up to 20 MW with products ranging from compact products to custom-engineered solutions. Our connected devices offer built-in intelligence to improve operational efficiency, availability, and functional safety in various application areas, such as industrial processes, machines, or buildings.

Explore our offer

- [Altivar Process](#)
- [Altivar Machine](#)
- [Altivar Building](#)
- [Altivar Soft Starters](#)

Life Is 

Schneider
Electric



Environmental Data Program

Enhance sustainability with Altivar™ Soft Starter ATS490

Superior environmental performance thanks to high durability

Altivar™ Soft Starter ATS490 is **RoHS** and **REACH** compliant

- Transparent environment information
- Life Cycle Analysis, compliant with ISO 14025
- Circularity profile

Altivar Soft Starter ATS490 brings key benefits to help you achieve **superior sustainability** thanks to **high-durability performance**:

- by increasing the reliability of the system to maximize process continuity and operations
- by allowing hardware and firmware upgradability to extend the lifetime of the equipment and keep it up to date
- by providing repairability and diagnostics to minimize downtime

Durability = Reliability + Upgradability + Repairability

Benefits

- Maximize **process continuity and operation**
- Reduce your **operational expenditure**
- Optimize your **maintenance cost** with proactive maintenance
- Improve the **performance** of your application
- Provide the IEC/EN 61508 certified **STO safety function**
- Reduce your **engineering time and cost**
- Lower **execution time** with integrated functions
- Enhance **sustainability**
- **Extend the service life** of your equipment



Altivar™ Soft Starter ATS490 is designed for high-durability performance

Visit the Altivar Soft Starter ATS490 web pages on se.com to access environmental data

Reliability

The Altivar Soft Starter ATS490 has been designed to deliver enhanced reliability to **withstand high stress**, whatever the origin - whether thermal, mechanical, chemical, or operational - to reduce downtime.

Additionally, the ATS490 integrates IEC 62443-4-2 SL1 certified **cybersecurity features** that help to protect against casual or coincidental violation, as well as the IEC/EN 61508 certified SIL1 **Safe Torque Off function** to help protect operators.

To avoid unplanned downtime, the ATS490 also **embeds condition monitoring** of the **soft starter** and the **driven equipment** by detecting deviation at an early stage to move to proactive condition-based maintenance.

Upgradability

Hardware and firmware upgrades are available. You can upgrade your Altivar Soft Starter ATS490 by adding either a **module in the dedicated slot** or an external option.

It is also possible to **upgrade the ATS490 firmware**. Available on the Schneider Electric website, the firmware is digitally signed and authenticity is verified by the ATS490.

Repairability

The Altivar Soft Starter ATS490 is designed to simplify on-site maintenance and repair processes thanks to integrated **diagnostic functions**, **spare parts** available from stock, and fast, **documented replacement** operations.

In addition, Schneider Electric implements a **circular model**, offering replacement with repaired or refurbished products so that your asset can be put back into service quickly.

Contents

Altivar Soft Starter ATS490

Altivar Soft Starter selection guide	page 4
■ General presentation	page 8
■ Altivar Soft Starter ATS490 presentation	page 12
■ Selection criteria	
□ Selection criteria for Altivar Soft Starter ATS490	page 20
□ Normal and heavy duty applications	page 21
□ Selection of ATS490 commercial reference	page 22
□ Special uses	page 23
■ ATS490 soft starter references	
□ Connection in-line, motor power in kW	page 25
□ Connection inside motor delta, motor power in kW	page 26
□ Connection in-line, motor power in HP	page 27
□ Replacement parts	page 28
■ Configuration and runtime tools	
□ Graphic display terminal	page 29
□ Accessories for graphic display terminal	page 30
□ Multidrop connection accessories	page 30
□ DTM	page 31
□ SoMove software	page 32
■ Options	
□ Soft starter/accessories and options combinations	page 33
□ Communication buses description and functions	page 34
□ Integrated communication protocols	page 35
□ Optional communication modules	page 37
□ Firmware update	page 39
□ Line chokes and protective covers	page 41
■ Motor starter combinations	
□ Presentation	page 42
□ Type 1 coordination	page 43
□ Type 2 coordination	page 47
□ Line contactor reference table	page 51
■ Dimensions	
□ Soft starters	page 52
□ Line chokes	page 52
Services	
■ A whole world of services for your drives	page 53
Index	
■ Product reference index	page 55

Schneider Electric's IoT-enabled, plug-and-play, open, secure, interoperable architecture and platform, in Industries, Infrastructures, Data Centers, and Buildings.

Innovation at every level

EcoStruxure is based on a three-tiered technology stack delivering innovation at every level, from connected products to edge control and apps, analytics, and services.

Together with our hybrid segments approach, this enhances your value around safety, reliability, operational efficiency, sustainability, and connectivity across 6 domains of expertise:

- Power
- IT
- Building
- Machine
- Plant
- Grid

Dedicated architectures and IoT

We tailor our solutions in the form of dedicated reference architectures for plants:

- Management systems
- Power systems
- Data center systems
- Industrial plant and machine systems
- Smart grid systems

The Industrial Internet of Things (IIoT) gives an additional boost to technologies. That's why we provide our customers with an IoT-enabled architecture and platform offering simple, reliable, productive, and cost-efficient solutions.

Cybersecurity solutions

Robust cybersecurity protection is a must, and Schneider Electric's solutions can deliver it, regardless of business type or industry.

The vendor-agnostic services provided by our skilled professionals help to protect your entire critical infrastructure. We help to assess your risk, implement cyber-specific solutions, and maintain your onsite defenses over time, while integrating appropriate IT policies and requirements.

This is our difference and your advantage.

Enhanced safety

With the release of M580 Safety, Schneider Electric further expands the EcoStruxure platform.

This consolidates our position as one of the most trusted industrial safety vendor, with thousands of Modicon and Triconex safety systems protecting the most critical industrial processes globally.







EcoStruxure™ for Industry
Innovation At Every Level



*The Schneider Electric industrial software business and AVEVA have merged to trade as AVEVA Group plc, a UK listed company. The Schneider Electric and Life is On trademarks are owned by Schneider Electric and are being licensed to AVEVA by Schneider Electric.



Altivar Soft Starter

Soft starters for asynchronous motors
Altivar Soft Starter ranges

Market segments		Simple machines			Industrial machines		
Applications		Simple starting	Simple starting and stopping		Controlled starting and stopping of pumps, fans, compressors, agitators, mixers, conveyors	Simple starting and stopping of pumps and fans	
							
Operational voltage range Ue (V)		110...480	200...480	200...480	208...600	230...440	208...600
Operational current range Ie (A)		3...25	6...32	38...105	17...590	17...590	17...590
Power range		For 50...60 Hz line supply (kW/HP)					
Single-phase 110...230 V (kW)		0.37...2.2	–	–	–	–	–
Three-phase 200...240 V (kW/HP)		–	0.75...7.5/1...10	–	–	–	–
200...480 V (kW/HP)		0.37...11/0.5...15	–	–	–	–	–
208 V (HP)		–	–	10...30	3...150	–	3...150
230...240 V (kW/HP)		–	–	11...30/10...40	4...160/5...200	4...160/–	4...160/5...200
380...440 V (kW)		1.1...11	1.5...15	18.5...55	7.5...355	7.5...355	7.5...355
460...480 V (HP)		0.5...15	2...20	25...75	10...400	–	10...400
500...525 V (kW)		–	–	–	9...400	–	9...400
575 V (HP)		–	–	–	15...500	–	15...500
Motor control		Operating cycle		Normal duty	500% current rating (700% rated motor current)		350% current rating
Current limiting		–		–	–		–
Boost		–		Yes	–		–
Type of control		Configurable voltage ramp		–	Torque control (TCS = Torque Control System), voltage control		Configurable voltage ramp
Deceleration		Voltage ramp		–	Torque ramp, voltage ramp		Voltage ramp
Braking		–		–	–		–
Number of controlled phases		1	2	–	–		3
Connection inside the motor delta		–		–	–		Yes
Bypass		Integrated		–	–		–
Functions		Thermal protection		External	Electronic embedded, or with PTC 1/3 resistors in series, 2 wires		Electronic embedded, or with PTC
Other protections		–		Soft starter overheating	Underload, overload, motor phase loss, line phase inversion, motor phase inversion, excessive acceleration time, current overload, ground leakage, undervoltage, overvoltage, unbalance, time before restart.		Underload, overload, motor phase loss, line phase inversion, excessive acceleration time, current overload, ground leakage
Safety functions		–		–	–		–
Cybersecurity		–		–	Yes		–
Condition monitoring		–		–	Energy, power consumption, power quality Soft starter: fan(s), bypass relays		Energy, power consumption
Application functions		–		–	Preheating, smoke extraction, voltage boost		Second motor set, voltage boost
Communication		Embedded		–	Modbus serial link (RJ45), Modbus serial link (open style)		Modbus serial link
Option modules		–		–	–		–
Configuration and runtime tools		2 potentiometers	3 potentiometers	–	Integrated plain text display terminal, graphic display terminal (optional), DTM (device type manager), SoMove software		7-segment display, SoMove software
Number of I/O		Analog inputs		–	PTC 1/3 resistors in series, 2 wires		1 PTC probe
Digital inputs		–		–	4		3
Analog outputs		–		–	1		–
Digital outputs		–		–	–		–
Relay outputs		–		1	–		–
Standards and certifications		IEC/EN 60947-4-2 CE, UL, CSA, C-Tick, CCC		IEC/EN 60947-4-2 CE, CCC, UKCA, EAC, RCM	IEC/EN 60947-4-2, EMC class A, CE, cULus, UKCA, RCM, CCC, REACH, RoHS		IEC/EN 60947-4-2, EMC class A CE, UL, CSA, C-Tick, GOST, CCC
References		ATS01N1●●●●	ATS01N2●●●●	ATS130N2●●●LT	ATS430●●●S6	ATS22●●●Q	ATS22●●●S6●

Altivar Soft Starter

Soft starters for asynchronous motors
Altivar Soft Starter ranges

Market segments	Process and infrastructure, demanding machines	
Applications	Controlled starting and stopping of pumps, fans, compressors, agitators, mixers, grinders, crushers, refiners, conveyors, lifting screws, presses	
		
Operational voltage range Ue (V)	208...690	
Operational current range Ie (A)	17...1,200	
Power range	For 50...60 Hz line supply (kW/HP)	
	Three-phase 208 V (HP)	4...900/3...1,200
	230...240 V (kW/HP)	3...400
	380...440 V (kW)	4...355/5...450
	460...480 V (HP)	7.5...710
	500...525 V (kW)	10...1,000
	575 V (HP)	9...800
	660...690 V (kW)	15...1,200
		11...900
Motor control	Operating cycle	Normal duty and heavy duty
	Current limiting	500% current rating (700% rated motor current)
	Boost	Yes
	Type of control	Torque control (TCS = Torque Control System), voltage control
	Deceleration	Torque ramp, voltage ramp
	Braking	Yes
	Number of controlled phases	3
	Connection inside the motor delta	Yes
	Bypass	External with soft starter optimization or without bypass
Functions	Thermal protection	Electronic embedded, with PTC, or with PT100 2/3 wires
	Other protections	Underload, overload, motor phase loss, line phase inversion, overcurrent, excessive acceleration time, current overload, ground leakage
	Safety functions	–
	Cybersecurity	Yes
	Condition monitoring	Energy, power consumption
	Application functions	Preheating, smoke extraction, voltage boost, multimotor cascade, second motor set
Communication	Embedded	Modbus serial link
	Option modules	Modbus TCP, EtherNet/IP, PROFIBUS DP V1, CANopen daisy chain, SUB-D, and screw terminal block
Configuration and runtime tools		Plain text display terminal, graphic display terminal (option), DTM (device type manager), SoMove software
Number of I/O	Analog inputs	PTC or PT100 2/3 wires
	Digital inputs	4
	Analog outputs	1
	Digital outputs	2
	Relay outputs	3
Standards and certifications	IEC/EN 60947-4-2, EMC class A and B CE, cULus, UKCA, CCC, RCM, KC, EAC, DNV, ABS, BV, CCS, REACH, RoHs	IEC/EN 60947-4-2, EMC class A CE, cULus, UKCA, RCM, CCC, DNV, REACH, RoHS
References	ATS480●●●Y	ATS490●●●Y

Altivar Soft Starter ATS490

Soft starters for asynchronous motors

Improve operational resilience and competitiveness, enhance sustainability



Altivar Soft Starter ATS490 range

Your assets are the priority

Altivar Soft Starter ATS490 is the new comprehensive range of soft starters from Schneider Electric providing advanced motor management for the majority of industrial applications that offers operational performance, reliability, complete monitoring, integration in the automation system, and energy efficiency.

Altivar Soft Starter ATS490 has been designed to deliver:

- High-durability performance to maximize uptime with service life
- Superior sustainability
- Cost reduction at each phase of the service life

ATS490 covers the operational voltage range from 208 to 690 V in a single product range up to 1,200 A, meets the requirements of the most stringent applications in normal and heavy duty, and embeds innovative features that simplify the equipment and its design while minimizing risks through certification.

Improving operational resilience

Altivar Soft Starter ATS490 is designed to help ensure continuity of operation. The high-durability performance of ATS490 applies not only to the product itself but also to the whole system to avoid disruption and reduce downtime.

Durability = Reliability + Upgradability + Repairability

Enhanced reliability

ATS490 withstands high stress from several origins, whether environmental or operational. It offers enhanced robustness against:

- > Thermal conditions with an extended ambient operating temperature from -25 to 60 °C/-13 to 140 °F (with derating above 40 °C/104 °F)
- > Mechanical conditions by using a long-lasting power connection with integrated EverLink™ technology and complying with class 3S3 according to IEC 60721-3-3
- > Chemical conditions by complying with class 3C3 according to IEC 60721-3-3 ed. 2002 with salt mist
- > Electrical conditions thanks to a large mains voltage range from 208 to 690 V and a large mains frequency range from 50 or 60 Hz +/-20%

The reliability on operating stress is also reinforced by TCS, the original Torque Control System by Schneider Electric, and by its starting capabilities that include high starting duration and high number of starts per hour.

Certified cybersecurity functions

As limiting events causing downtime are not specifically related to equipment, the Altivar Soft Starter ATS490 integrates IEC 62443-4-2 cybersecurity features certified by TÜV Rheinland with a development process that is IEC 62443-4-1 certified. The embedded functions include:

- > User account management that includes user authentication, authorization according to the role of the user, access channels, and strong passwords
- > Hardening to restrict access to communication ports and related functions or services
- > Threat intelligence to manage cybersecurity-related events
- > Cybersecurity-compliant firmware upgrade



Altivar Soft Starter ATS490

Soft starters for asynchronous motors

Improve operational resilience and competitiveness,
enhance sustainability



Native ATS490 functions simplify architecture and increase operational resilience



ATS490 with an optional module in the slot

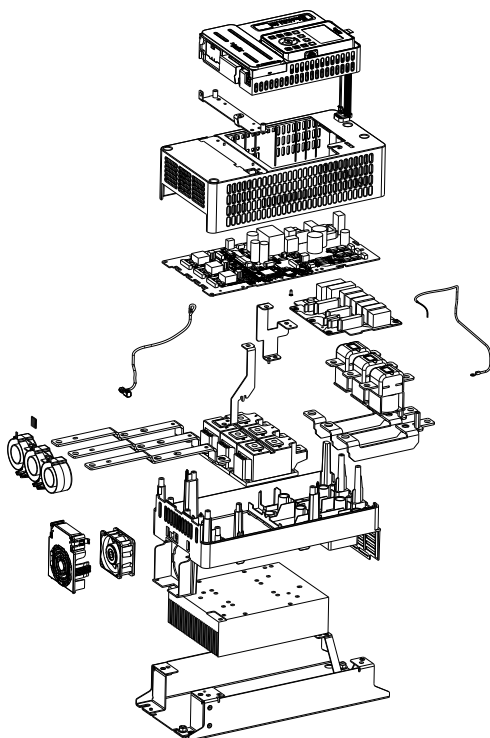

Improving operational resilience (continued)

Certified Safe Torque Off function

ATS490 embeds the Safe Torque Off function compliant with IEC 61508 Safety Integrity Level 1 and certified by INERIS and TÜV Sud. The STO function brings the machine or functional unit to a no-torque state and prevents it from starting accidentally without an external line contactor.

Integrated condition monitoring for asset management

To avoid unplanned downtime and move to a proactive maintenance strategy, Altivar Soft Starter ATS490 embeds instrumentation and data processing to allow early detection of deviation in operation of the ATS490 and of the driven equipment including the motor and the application.

- > ATS490 provides warnings in the event of operational deviation in its most sensitive parts (fans and bypass relays).
- > A Discrete Fourier Transform (DFT) is also embedded to detect operational deviation in the driven equipment. The results of the DFT are transferred through any communication fieldbus. Additional devices are not necessary as ATS490 integrates the instrumentation, data collection at a fast sampling time, high-speed data processing, and storage.
The source of a deviation - electrical power supply or application - can easily be identified according to the frequency of the disturbances.

Condition monitoring with Altivar Soft Starter ATS490 is architecture agnostic with monitoring on the supervisory control, as a standard automation architecture can be used without oversizing the servers or adding an additional sub-system.

Upgradability

It is easy to extend the service time of the equipment with ATS490 and keep it up to date. Two types of upgrade are possible:

- > Firmware upgrade:
The firmware is available on the Schneider Electric website and the upgrade can be performed directly by customers with SoMove or EcoStruxure Automation Device Maintenance software over an Ethernet port or Modbus Serial port. Firmware upgrades follow the cybersecurity rules in terms of authorization and authenticity.
- > Hardware upgrade, by adding an optional module in the dedicated slot of the ATS490 or by adding external options.

Repairability

To reduce the Mean Time To Repair (MTTR) and therefore minimize downtime, the Altivar Soft Starter ATS490 offers:

- > Diagnostics: online help on the graphic display terminal, direct access to troubleshooting by using the dynamic QR code or QR code to documentation
- > Wear parts, such as fans and control board, available with documented operation for easy replacement by the user
- > Spare parts, such as bypass contactor, power board, and thyristors, available for replacement by Schneider Electric after-sales service or authorized partners

In addition, Schneider Electric implements a circular model offering replacement with repaired or reconditioned products.

Superior sustainability

Energy efficiency and management

The functions and capabilities of the ATS490 allow advanced motor management to deliver efficient energy management:

- > Efficiency higher than 99.5%
- > Integrated bypass
- > Power monitoring with accuracy better than 95%: current, voltage, power factor, active and reactive power, active and reactive energy
- > Power quality monitoring: voltage sag, voltage and current unbalance, Thd-I, Thd-U

Direct energy management capabilities are provided thanks to integration in EcoStruxure Power Monitoring Expert, by combining power and energy data provided by ATS490 and process data according to different stand points.

Preserved resources

- > Use of plastic with at least 20% bio-based content
- > Use of ASI-certified aluminum for responsible production, sourcing, and material stewardship
- > Packaging using recycled cardboard

Environmental data

ATS490 meets the following requirements:

- > Use of hazardous substances
 - Compliance with the European RoHS directive (2011/65/EU and 2015/863/EU) and RoHS China
 - Compliance with REACH regulation No.1907/2006 for the declaration of substances of very high concern (SVHC), authorization (Annex XIV), and restriction (Annex XVII)
- > Environmental impact

The Product Environmental Profile (PEP) is a quantitative Type III Environmental Declaration in compliance with ISO 14025 that helps to ensure appropriate reliability and transparency. Based on a Life Cycle Assessment (LCA) of the product along its whole life cycle, the document presents the different impacts such as energy consumption, carbon footprint, consumption of raw materials, and pollution of air, water, and soil.
- > End-of-Life management

The "ATS490 End-of-life" information document in accordance with IEC 62635 guidance contains the instructions for a responsible disposal of the products and maximizes recycling in a step towards a more circular economy, improving operational efficiency and reducing environmental hazards.

Please consult the Altivar Soft Starter ATS490 product pages on our website to access the environmental data of the given reference: environmental and carbon footprint data, material and substances data, energy efficiency data, service life extension, repacking and remanufacturing data.





Contributing to greater competitiveness

Reduce engineering time and cost

With EcoStruxure tools, the engineering time is drastically reduced:

- > Just two minutes to select the complete soft starter solution with EcoStruxure Motor Control Configurator: no need to be an expert
- > Optimization of the power architecture with EcoStruxure Motor Management Design
 - Analysis of different solutions
 - Selection of the preferred devices according to the architecture
- > Definition of the architecture and detailed design with EcoStruxure Architecture Builder including the Bill of Material and quotation

Furthermore, the certified cybersecurity and safety functions simplify the design and minimize the risks.

Reduce the overall cost of the solution

Altivar Soft Starter ATS490 embeds functions that avoid the need for external devices:

- > Embedded Ethernet port for Modbus TCP and EtherNet/IP communication
- > No need for a line contactor with the integrated Safe Torque Off function
- > No need for external instrumentation and device for energy management with the embedded power monitoring and power quality functions
- > No need for external sub-system to monitor the condition of the driven equipment thanks to the condition monitoring features that integrate measurement, data collection, data processing, and results storage functions

Reduce execution time

- > With the ATS490 DTM, associated derived function block (DFB), and faceplate you can:
 - Quickly write the PLC program in EcoStruxure Control Expert
 - Integrate a ready-to-use faceplate in AVEVA System Platform
 - Adapt and modify parameters without stopping the installation
 - Set, monitor, and diagnose from the engineering station
(The DFB and faceplate are available in the General Purpose library).
- > Fewer devices to be mounted and wired
- > No sensor to install, no configuration and additional tool to set up the condition monitoring of the driven equipment.
- > Easy test of wiring and settings before installation on site:
 - Simulation mode to test the automation application without motor and power supply
 - Small motor test to validate the motor wiring
 - Test procedure when the ATS490 is connected inside the motor delta

Reduce your operational expenditure (OpEx)

The ATS490 allows advanced motor management to:

- > Reduce your energy bill
 - High efficiency level of ATS490 (99.5%) thanks to integrated bypass
 - Embedded power and energy monitoring and management
- > Increase uptime with a high-durability device
- > Reduce maintenance cost by moving from reactive maintenance to condition-based maintenance thanks to the embedded condition monitoring of the ATS490 and of the driven equipment
- > Help to protect your process integrity against casual or coincidental violations thanks to the embedded IEC/EN 62443-2 SL1-certified cybersecurity features
- > Help to protect your operators thanks to the integrated Safe Torque Off function certified according to IEC 61508 SIL1 and EN 13849 Cat.2 PLC

Altivar Soft Starter ATS490

Soft starters for asynchronous motors

Segment, applications, EcoStruxure Plant integration

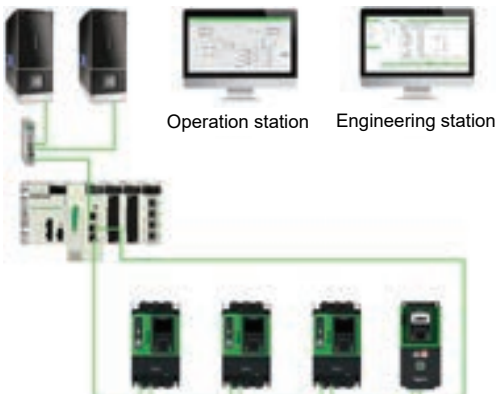

Process, infrastructure, and industrial machines

Altivar Soft Starter ATS490 is specifically designed to meet the requirements of the following market segments:

- Water and wastewater
- Oil and gas
- Mining, minerals, and metals
- Food and beverage
- Marine

ATS490 also meets the needs of industrial machines.

The Altivar Soft Starter ATS490 range increases the durability and availability of your assets, helps to ensure continuous operation, and reduces downtime thanks to its:

- Torque Control System (TCS)
- Simplicity
- Connectivity
- Communication services
- Robustness
- Integrated bypass relays
- Condition monitoring functions
- Cybersecurity features

Applications

The Altivar Soft Starter ATS490 helps to ensure soft starting and stopping even for the most demanding applications, while reducing mechanical wear and fluid shocks in hydraulic applications.

ATS490 features include:

- Sized for normal duty and heavy duty applications
- Controlled acceleration thanks to TCS, the original torque control system
- Controlled deceleration thanks to TCS, the original torque control system
- Efficient dynamic braking and DC injection down to zero speed to stop high-inertia applications
- Up to 700% motor current starting without tripping
- Boost function to override locked shaft, friction
- Forward/reverse management
- Smoke extraction
- JOG
- Anti-jam
- Borehole pump starting

EcoStruxure Plant integration

The association of Altivar Soft Starter ATS490 with Schneider Electric automation control systems like EcoStruxure Process Expert (for hybrid systems) offers a high-performance, global automation and motor control solution with optimized total cost of ownership (TCO).

The solution provides operational integrity for people, processes, and assets, with improved maintenance support to help reduce downtime and ensure operational continuity.

It offers operational insight by accessing more information to optimize the process. Based on market standards (FDT/DTM, Ethernet, etc.), it is a sustainable, scalable solution that enables processes to be adapted easily and affordably.

An integrated automation system powered by EcoStruxure offers the following benefits:

- More efficient projects
- Optimized operations

Altivar Soft Starter ATS490

Soft starters for asynchronous motors

The offer



ATS490_SIZE_1A1_Default

The offer

The Altivar Soft Starter ATS490 is a controller with six thyristors using the TCS (Torque Control System) algorithm to control acceleration, deceleration, and stopping of three-phase squirrel cage asynchronous motors up to 900 kW/1,200 HP.

- The ATS490 is a cost-effective solution designed to:
 - Reduce machine operating costs by reducing mechanical stress and improving machine availability
 - Reduce the risk of severe damage by reducing fluid shocks and improving installation availability
 - Reduce the stress on the electrical distribution system by reducing line current peaks and voltage drops during motor starts
 - Reduce the installation cost thanks to the integrated bypass relays
 - Improve reliability of your asset thanks to embedded features such as condition monitoring and cybersecurity
 - Help to protect personnel with integrated STO function

Altivar Soft Starter ATS490 consists of one range only covering:

- Operational voltage from 208 to 690 V
- Operational current from 17 to 1,200 A

The ATS490 control circuit supply voltage is 110 to 230 V and is required to start the motor. The control part of ATS490 (control board, graphic display terminal, and fieldbus) can be powered by an external 24 VDC supply to keep communication, display, and diagnostics functions operating even when the mains power supply is shut down.

The ATS490 integrates the following communication protocols as standard:

- Modbus serial line communication. Each device is equipped with two independent RJ45 serial ports for:
 - Connection to configuration and firmware update software
 - Connection of the graphic display terminal
 - Connection to a Modbus fieldbus
- Modbus TCP, EtherNet/IP communication. Each device is equipped with one RJ45 Ethernet port.
 - Connection to configuration and firmware update software
 - Connection to a Modbus TCP fieldbus
 - Connection to EtherNet/IP fieldbus
 - Connection to the embedded Web server

In addition, the ATS490 is equipped with one slot for an optional CANopen or PROFIBUS DP communication module.

Robust

The Altivar Soft Starter ATS490 is designed to adapt to the harshest environments.

- Ambient operating temperature:
 - 25...40 °C/-13...104 °F without derating, up to 60 °C/140 °F with derating of 1% per °C above 40°C/104°F
- Relative humidity without condensing: 5...95%
- Storage and transport temperature: -40...70 °C/-40...158 °F
- Withstand to harsh environments:
 - Conforming to IEC/EN 60721-3-3 ed. 2002
 - Chemical substances class 3C3 with salt mist
 - Mechanical substances class 3S3
 - Printed circuit boards with protective coating
- Operating altitude:
 - 0...2,000 m/0...6,562 ft without derating
 - 2,000...4,800 m/6,562...15,748 ft with derating of 1% per 100 m/328 ft
 - Altitude also has an impact on the overvoltage category of the supply source (see the "System earthing arrangement and mains voltage" section)

Altivar Soft Starter ATS490

Soft starters for asynchronous motors

The offer

The offer (continued)

System earthing arrangement and mains voltage

To comply with IEC 60947-1, the system earthing arrangement, mains voltage used on the ATS490, and the altitude define the overvoltage category of the supply source.

Mains voltage	System earthing arrangement	Supply source overvoltage category required according to altitude	
		Up to 2,000 m/6,562 ft	From 2,000 to 4,800 m/6,562 to 15,748 ft
208...480 V	TT or TN	OVCIII	OVCIII
	IT or corner grounded	OVCIII	OVCII
480...600 V	TT or TN	OVCIII	OVCII
	IT or corner grounded	OVCIII	OVCII
600...690 V	TT or TN	OVCIII	OVCII
	IT	OVCII	–

The supply source overvoltage category could be reduced by using an appropriate system such an insulation transformer.

Installation

The ATS490 is intended to be mounted in a cabinet. The protection rating of the products is as follows:

- IP20 for current rating from 17 to 110 A
- IP00 for current rating from 140 to 1,200 A

The units from 140 to 1,200 A have unprotected power terminals. For units from 140 to 660 A, these terminals can be fitted with protective covers (see [page 41](#)). The protective covers are to be used with eyelet connections.

Electromagnetic compatibility (EMC)

Compliance with electromagnetic compatibility requirements has been incorporated into the design of the Altivar Soft Starter ATS490 to help to ensure equipment meets CE marking requirements.

Radiated and conducted emissions according to IEC 60947-4-2 environment A applies on all ATS490 ratings.

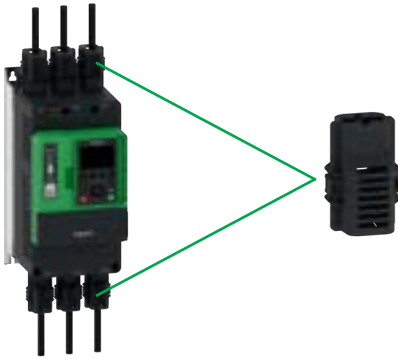

Altivar Soft Starter ATS490 equipped with optional protective covers

Altivar Soft Starter ATS490

Soft starters for asynchronous motors

The offer

The offer (continued)

Applications for explosive atmospheres (ATEX)

The Safe Torque Off (STO) safety function is an ATEX-certified function according to the ATEX 94/9/EC directive and 2014/34/EU directive.

The use of the STO safety function is required for the ATS490 soft starter to control and command motors installed in an explosive atmosphere (ATEX).

The ATEX-certified motor must be equipped with ATEX-certified thermal sensor(s). The switching system (ATEX-certified) embedded in the thermal sensor, or included in the thermal protection control unit (also ATEX-certified) of the ATEX motor, must be connected to the STO input of the ATS490 soft starter.

In the event of the ATEX motor reaching an excessive temperature, the control system triggers the STO safety function. The electrical power of the motor is cut to help ensure that the temperature of the motor frame remains below the maximum temperature depending on the gas or the dust atmosphere in which the ATEX motor is installed.

The Altivar Soft Starter ATS490 must be installed outside the hazardous Ex zone.

Please refer to the [ATS490 - ATEX manual for applications in explosive gas atmosphere or in the presence of combustible dust](#).

Certification and marking

The Altivar Soft Starter ATS490 range has the following certifications: cULus, CE, UKCA, CCC, RCM, DNV, REACH, RoHs Europe, RoHs China, PEP ecopassport, CE ATEX, IECEx, Cybersecurity IEC 62443-4-2 SL1, Safety STO IEC 61508 SIL1, and EN 13849 Cat.2 PLc.

Marking: CE, cULus, CCC, RCM, UKCA, CE ATEX, Safety SIL1, Cybersecurity SL1.



Altivar Soft Starter ATS490

Soft starters for asynchronous motors

Integrated functions

Integrated functions

The Altivar Soft Starter ATS490 includes numerous functions related to monitoring, the application, and start/stop performance, including:

- TCS, the original torque control system: constant control of the torque supplied to the motor during acceleration and deceleration phases (significantly reducing pressure surges)
- Dynamic braking
- Bypassing function of the six thyristors, managed by the integrated relays, at the end of a start period whilst maintaining electronic protection
- Wide frequency tolerance for generator set power supplies
- Wiring diagnostics functions:
 - Small motor test
 - Inside the motor delta wiring test and validation
- Simulation mode to test the automation application without motor and power supply

Protection of personnel

The Altivar Soft Starter ATS490 embeds a Safe Torque Off (STO) function certified according to IEC 61508 SIL1 and EN 13849 Cat.2 PLC.

Condition monitoring

The Altivar Soft Starter ATS490 embeds condition monitoring functions to improve uptime and reduce the maintenance cost of your assets.

- Condition monitoring of the most sensitive parts of the ATS490 (fans and bypass relays)
- Condition monitoring of the driven equipment, based on Discrete Fourier Transform results, to detect deviation in operation and help to identify the source of the deviation

Power and energy monitoring

The Altivar Soft Starter ATS490 is equipped with nine measuring sensors (six voltage sensors and three current sensors) with better than 95% accuracy, monitoring each phase at mains supply and motor level:

- Power metering:
 - Active energy and reactive energy
 - Active power and reactive power
 - Mains voltage (global and phase-to-phase) and frequency
 - Motor current (global and per phase)
- Power quality
 - THDI and current unbalance
 - THDV, voltage unbalance, and voltage sag

Motor and mains monitoring

- Built-in motor thermal monitoring
- Connection of PTC, PT100, PT1000, or KTY probes
- Time before restart based on estimated motor thermal status
- Pump cycling protection
- Phase rotation
- Phase loss
- Mains loss
- Excessive starting time locked rotor
- Underloads and overcurrent during continuous operation
- Main phase inversion



ATS490 in Power Monitoring Expert

Integrated functions (continued)

Application functions

- Smoke extraction
- Boost
- Current switch limitation
- Torque limitation
- Second set of motor parameters
- Motor preheating
- Forced local mode
- Automatic restart
- JOG
- Anti-jam
- Borehole pump
- Forward/reverse management with external contactors

Cybersecurity

The Altivar Soft Starter ATS490 embeds IEC/EN 62443-2 SL1-certified cybersecurity features as standard. These features contribute to the enhanced protection of your process against casual or coincidental violations from insiders, such as well-intentioned yet careless employees or contractors with no cybersecurity attack skills, which represent 60% of cyberattacks.

Cybersecurity features help to:

- Enforce authorization of users through:
 - User profile assignment
 - User authentication
 - Administrator ability to override user authorization
 - Strong password requirement
 - Password encrypted in a non-reversible way
 - After-sales service authorization
 - Authorization managed according to channels
- Restrict and disable functions or services:
 - Sign-in required after a configurable period of inactivity
 - Prohibit or restrict the use of ports, protocols
 - Enable/disable services: e.g. SNMP service
 - Counter brute force attacks by blocking repeats login attempt
 - Cybersecurity events recorded in dedicated database
 - Reports include user's name, type of operation, time stamp
 - Alert when storage capacity is approaching
 - Storage capacity up to 500 logins
 - 10 years battery lifetime, alert when low battery is approaching
- Protect authenticity of the firmware through:
 - Digitally signed firmware
 - Cryptographic firmware keys
 - Original firmware stored in secure location
 - Verification of firmware validity on each power-up
 - Verification of operation of the Altivar Soft Starter
- Lock the hardware topology:
 - Prevents unauthorized addition or exchange of a communication module

Cybersecurity settings can be exported from the ATS490 as an individual file that can be saved and duplicated by transfer to other ATS490 devices.



Cybersecurity for your assets



Altivar Soft Starter ATS490

Soft starters for asynchronous motors

Integration

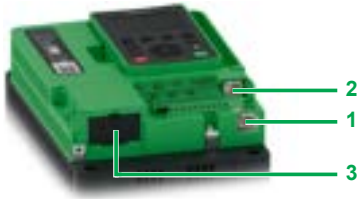

ATS490 soft starter ports

Integration

Embedded fieldbus protocol

- Modbus serial link with RJ45 port **1**
- Standard Modbus
- Connection of configuration and runtime tools
- Control of the Altivar Soft Starter ATS490 in automation architectures (PLCs, IPCs, HMIs, etc.) in industrial network protocols for reading/writing data: diagnostics, supervision, and fieldbus management functions
- Modbus TCP, EtherNet/IP link with RJ45 port **2**
- SNMP, SNTP, BOOTP, DHCP, IP V6, cybersecurity services, FDR
- Embedded Web server

Optional communication modules

The following fieldbus protocols are available as an option module to be inserted in communication port **3**:

- CANopen bus
- CANopen daisy chain module with two RJ45 ports
- CANopen SUB-D module
- CANopen with screw terminal block module
- PROFIBUS DP

Integration of configuration and runtime tools

FDT/DTM technology within EcoStruxure Control Expert (see [page 31](#)):

- ATS490 configuration
- Diagnostics
- Control
- Monitoring





Graphic display terminal VW3A1111

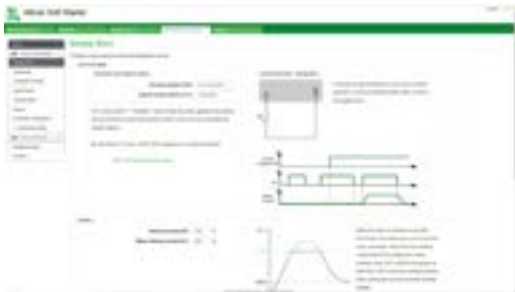

Web server



SoMove software



Dynamic QR code

Dialog and configuration tools

The graphic display terminal is delivered as standard mounted on the front face of the Altivar Soft Starter ATS490 and can be door-mounted with an IP65 protection rating using a dedicated door mounting kit.

The graphic display terminal is used for:

- ATS490 control, adjustment, and configuration
- Configuration storage and download (1)
- Duplication of the configuration of one powered-up ATS490 to another powered-up ATS490 (1)
- Copying configuration files from a PC or the graphic display terminal of an ATS490 and duplicating them on another ATS490 (the soft starter must be powered-up for the duration of the duplication operation) (1)
- Diagnostics
- Display of current values (motor, I/O, etc.) warning messages
- Access to digital portal via dynamic QR code
- When door-mounted, connection to several Altivar soft starters using multidrop link components (see [page 30](#))

A Web server is accessible through the Ethernet port to connect a laptop via a standard Ethernet cable. The Web server is used for:

- Commissioning the soft starter (setting configuration parameters and enabling the main functions)
- Monitoring energy and process data, as well as soft starter and motor data
- Diagnostics (status, file transfer, detected error and warning logs)

SoMove software

- Advanced functions for configuration, setup, cybersecurity policy, and maintenance of the Altivar Soft Starter ATS490

Services

The Altivar Soft Starter ATS490 features integrated services to achieve optimum time savings:

- Native simplicity to set up and start
- Simplified communication with integrated Modbus TCP, EtherNET I/P communication: Ethernet port with embedded Web server
- Help to secure firmware update:
 - Firmware version available on se.com from Altivar Soft Starter ATS490 web page
 - Single device firmware update using SoMove
 - Mass firmware update deployment using EcoStruxure Automation Device Maintenance
 - Applying the new firmware can be automatic or manual
 - Applying a new version is only possible when the Altivar Soft Starter ATS490 has validated the digital signature of the firmware. If this is not the case, the ATS490 will restart on the firmware version that was previously installed.
- Firmware update is available on ATS490 products, optional communication modules, and graphic display terminal languages
- Three types of QR code available:
 - QR code located on the front face of the product, to access the:
 - digital Customer Care Center application
 - product data sheet
 - ATS490 ID card and documentation
 - Dynamic QR code generated when an error is detected (red screen):
 - Identification of the detected error and link to a description of probable causes and possible corrective actions
 - Custom QR codes with links to your own support pages

(1) Upload, storage, and download of configuration files require a graphic display terminal VW3A1111 with a firmware version V2.3IE58 or later.

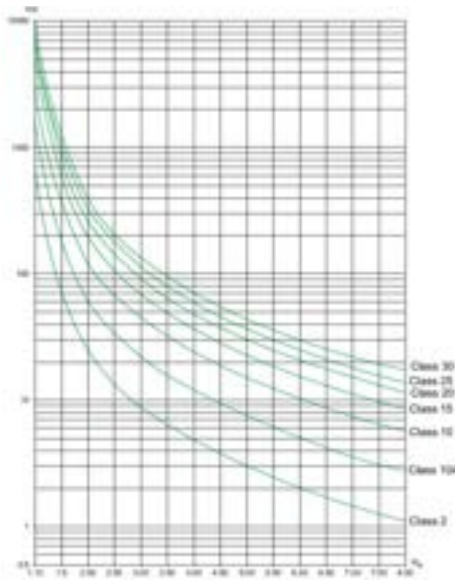

Normal and heavy duty applications

Depending on the type of machine, the applications are categorized as normal duty or heavy duty based on the starting characteristics, which are given as examples only in the table below.

Type of machine	Application	Functions performed by the Altivar Soft Starter ATS490	Starting current (% In)	Starting time (s)
Centrifugal pump	Normal duty	Deceleration (reduction in pressure surges) Detection of underload or reversal of phase rotation direction Automatic activation of anti-jam function on settable overload threshold	300	5 to 15
Piston pump	Normal duty	Control of pump priming and direction of rotation	350	5 to 10
Borehole pump	Normal duty	Starting of pump based on two torque limits, the first one higher than the second to quickly reach a minimum flow and help ensure the proper lubrication of the bearings	300	up to 2
Fan	Normal duty Heavy duty if > 30 s	Detection of overloads caused by clogging or underloads (motor/fan transmission broken) Braking torque on stopping	300	10 to 40
Cold compressor	Normal duty	Monitoring, even for special motors	300	5 to 10
Screw compressor	Normal duty	Detection of reversal of phase rotation direction Contact for automatic draining on stopping	300	3 to 20
Centrifugal compressor	Normal duty Heavy duty if > 30 s	Detection of reversal of phase rotation direction Contact for automatic draining on stopping	350	10 to 40
Piston compressor	Normal duty	Detection of reversal of phase rotation direction Contact for automatic draining on stopping	350	5 to 10
Conveyor, transporter	Normal duty	Monitoring of overloads for incident detection or underloads for break detection JOG function in mechanical setting steps	300	3 to 10
Lifting screw	Normal duty	Monitoring of overloads for hard spot detection or underloads for break detection	300	3 to 10
Drag lift	Normal duty	Monitoring of overloads for jamming detection or underloads for break detection	400	2 to 10
Lift	Normal duty	Monitoring of overloads for jamming detection or underloads for break detection Constant starting with variable load JOG function in mechanical setting steps	350	5 to 10
Circular saw, band saw	Normal duty Heavy duty if > 30 s	Braking for fast stop	300	10 to 60
Pulper, butchery cutter	Heavy duty	Torque control on starting	400	3 to 10
Agitator	Normal duty	The current display indicates the density of the material	350	5 to 20
Mixer	Normal duty	The current display indicates the density of the material	350	5 to 10
Grinder	Heavy duty	Braking to limit vibrations during stopping, monitoring of overloads for jamming detection	450	5 to 60
Crusher	Heavy duty	Braking to limit vibrations during stopping, monitoring of overloads for jamming detection	400	10 to 40
Refiner	Normal duty	Torque control on starting and stopping	300	5 to 30
Press	Heavy duty	Braking to increase the number of cycles	400	20 to 60

Selection of ATS490 commercial reference

Once the appropriate application has been selected from the previous page, select the Altivar Soft Starter ATS490 from [page 25](#) according to the supply voltage and the motor power. Check that the rated motor current is lower than the operational current of the ATS490.

The Altivar Soft Starter ATS490 is designed to respect the operations shown in the table in the "Select normal duty or heavy duty application" section on [page 20](#) without triggering an overheat error at 40 °C/104 °F max. and at an altitude of 2,000 m/6,562 ft. Above those limits it is necessary to derate the operational current of the soft starter as follows:

- Derating of 1% per °C above 40 °C/104 °F up to 60 °C/140 °F
- Derating of 1% per 100 m/328 ft up to 4,800 m/15,748 ft

Breakdown of ATS490 product reference

	ATS	490	C	17	Y
Product range					
ATS Altivar Soft Starter					
Type					
490					
Factor for current rating					
D Current x 1					
C Current x 10					
M Current x 100					
Current multiplicand					
10-11-12-.....66-75-79-88					
Mains voltage					
Y 208 to 690 VAC					

For example, for the reference ATS490C17Y, the current rating is 170 A (17 x 10).
The current rating is defined as the rated operational current in normal duty, in-line, at 40 °C/104 °F.

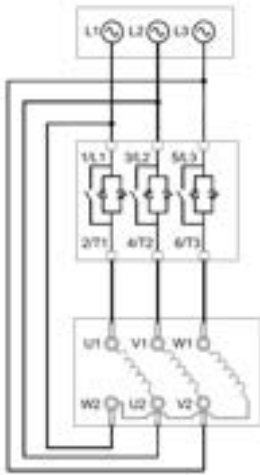

Soft starter wired in series with the motor windings

Special uses

Other use cases that influence the selection of the Altivar Soft Starter ATS490 are outlined below.

Connection inside the motor delta

In addition to the most frequently encountered wiring layouts, where the soft starter is installed in the line supply of the motor and the motor is connected in star or delta configuration, the ATS490 can be wired to the motor delta terminal in series with each winding (see the application diagram below). The soft starter current is lower than the line current absorbed by the motor by a ratio of $\sqrt{3}$. This type of installation enables a soft starter with a lower rating to be used.

Example: For a 400 V/110 kW motor with a line current of 195 A (current indicated on the motor nameplate for the delta connection), the current in each winding is equal to $195/\sqrt{3}$, i.e. 114 A.

Select the soft starter rating with a maximum permanent rated current just above this current, i.e. 140 A (ATS490C14Y for a normal duty application).

To avoid making this calculation, simply use the table on [page 25](#).

This type of installation only permits freewheel stopping and is not compatible with either the preheating function or the STO safety function.

Note: The rated current and current limiting settings as well as the current displayed during operation are on-line values (so do not have to be calculated by the user).

For this type of installation, observe the wiring scheme and the associated recommendations on [page 42](#).

Motors in parallel

Motors may be connected in parallel provided that the power limit of the soft starter is not exceeded (the sum of the motor currents must not exceed the rated current of the soft starter selected depending on the type of application). Install an external overload relay for each motor.

Special uses (continued)

Brush motor

The Altivar Soft Starter ATS490 can operate with a bypassed rotor resistance motor or with a resistance lug. The starting torque is modified in accordance with the rotor resistance. If necessary, maintain a low resistance in the rotor winding to obtain the required torque to overcome the resistive torque on starting.

A bypassed brush motor has a very low starting torque. A high stator current is required to obtain the sufficient starting torque.

Select an ATS490 soft starter with a limiting current equal to or higher than seven times the motor nominal current.

Note: Check that the motor starting torque, equal to seven times the rated current, is greater than the resistive torque.

Note: The ATS490 torque control enables excellent soft starting despite the current limit being seven times the rated current required to start the motor.

Dahlander motor and 2-speed motor

The ATS490 can operate with a 2-speed motor. A motor demagnetization period must elapse before changing from low speed to high speed in order to avoid antiphases between the mains supply and the motor, which would generate very high currents.

The ATS490 can save two sets of motor parameters that can be selected to optimize start/stop at both speeds. Select the soft starter using the three main criteria.

Very long motor cable

Very long motor cables cause voltage drops due to the resistance of the cable. If the voltage drop is significant, it could affect the current consumption and the torque available. This must therefore be taken into account when selecting the motor and the soft starter.

Soft starters in parallel on the same line supply

If several soft starters are installed on the same line supply, line chokes should be installed between the transformer and the soft starter (see [page 41](#)).

Restricted use

Do not connect the Altivar Soft Starter ATS490 to loads other than motors (for example, transformers and resistors are not allowed).

Do not connect power factor correction capacitors to the terminals of a motor controlled by an Altivar Soft Starter ATS490.

Altivar Soft Starter ATS490

Soft starters for asynchronous motors

Connection in-line

Motor power in kW

ATS490 in-line												
Motor nameplate							ATS490					Weight kg/lb
Rated operational voltage (Ue) Rated motor power							Reference	Operational rated current (Ie)	Power loss at Ie	Power loss during starting at 4xIe		
230 V	400 V	440 V	500 V	525 V	660 V	690 V					A	
kW	kW	kW	kW	kW	kW	kW						
Normal duty applications												
4	7.5	7.5	9	9	11	15	ATS490D17Y	17	2	202	3.8/8.4	
5.5	11	11	11	11	15	18.5	ATS490D22Y	22	4	281	3.8/8.4	
7.5	15	15	18.5	18.5	22	22	ATS490D32Y	32	8	405	5.8/12.8	
9	18.5	18.5	22	22	30	30	ATS490D38Y	38	11	431	5.8/12.8	
11	22	22	30	30	37	37	ATS490D47Y	47	17	560	5.8/12.8	
15	30	30	37	37	45	45	ATS490D62Y	62	7	675	7/15.4	
18.5	37	37	45	45	55	55	ATS490D75Y	75	11	914	7/15.4	
22	45	45	55	55	75	75	ATS490D88Y	88	15	1,113	7/15.4	
30	55	55	75	75	90	90	ATS490C11Y	110	32	1,471	7/15.4	
37	75	75	90	90	110	110	ATS490C14Y	140	26	1,651	9.5/20.9	
45	90	90	110	110	132	160	ATS490C17Y	170	38	2,101	9.5/20.9	
55	110	110	132	132	160	200	ATS490C21Y	210	48	2,725	19/41.9	
75	132	132	160	160	220	250	ATS490C25Y	250	64	3,034	19/41.9	
90	160	160	220	220	250	315	ATS490C32Y	320	60	4,326	19/41.9	
110	220	220	250	250	355	400	ATS490C41Y	410	99	5,480	19/41.9	
132	250	250	315	315	400	500	ATS490C48Y	480	108	6,212	28/61.7	
160	315	355	400	400	560	560	ATS490C59Y	590	164	7,847	28/61.7	
–	355	400	–	–	630	630	ATS490C66Y	660	205	9,247	28/61.7	
220	400	500	500	500	710	710	ATS490C79Y ▲	790	157	10,630	65/143	
250	500	630	630	630	900	900	ATS490M10Y ▲	1,000	251	13,619	65/143	
355	630	710	800	800	–	–	ATS490M12Y ▲	1,200	361	18,724	65/143	
Heavy duty applications												
3	5.5	5.5	7.5	7.5	9	11	ATS490D17Y	12	-	-	3.8/8.4	
4	7.5	7.5	9	9	11	15	ATS490D22Y	17	2	202	3.8/8.4	
5.5	11	11	11	11	15	18.5	ATS490D32Y	22	4	281	5.8/12.8	
7.5	15	15	18.5	18.5	22	22	ATS490D38Y	32	8	405	5.8/12.8	
9	18.5	18.5	22	22	30	30	ATS490D47Y	38	11	431	5.8/12.8	
11	22	22	30	30	37	37	ATS490D62Y	47	4	560	7/15.4	
15	30	30	37	37	45	45	ATS490D75Y	62	7	675	7/15.4	
18.5	37	37	45	45	55	55	ATS490D88Y	75	11	914	7/15.4	
22	45	45	55	55	75	75	ATS490C11Y	88	15	1,113	7/15.4	
30	55	55	75	75	90	90	ATS490C14Y	110	16	1,471	9.5/20.9	
37	75	75	90	90	110	110	ATS490C17Y	140	26	1,651	9.5/20.9	
45	90	90	110	110	132	160	ATS490C21Y	170	31	2,101	19/41.9	
55	110	110	132	132	160	200	ATS490C25Y	210	45	2,725	19/41.9	
75	132	132	160	160	220	250	ATS490C32Y	250	37	3,034	19/41.9	
90	160	160	220	220	250	315	ATS490C41Y	320	60	4,326	19/41.9	
110	220	220	250	250	355	400	ATS490C48Y	410	79	5,480	28/61.7	
132	250	250	315	315	400	500	ATS490C59Y	480	108	6,212	28/61.7	
160	315	355	400	400	560	560	ATS490C66Y	590	164	7,847	28/61.7	
–	355	400	–	–	630	630	ATS490C79Y ▲	660	109	9,247	65/143	
220	400	500	500	500	710	710	ATS490M10Y ▲	790	156	10,630	65/143	
250	500	630	630	630	900	900	ATS490M12Y ▲	1,045	251	13,619	65/143	

▲ Available Q2 2025

Altivar Soft Starter ATS490

Soft starters for asynchronous motors

Connection inside motor delta

Motor power in kW



ATS490D32Y

ATS490 inside motor delta						
Motor nameplate	ATS490					
Rated operational voltage (Ue)	Reference	Operational rated current (Ie)	Power loss at le	Power loss during starting at 4xIe	Weight	kg/lb
Rated motor power						
230 V	400 V	A	W	W		
kW	kW					
Normal duty applications						
7.5	15	ATS490D17Y	17	2	202	3.8/8.4
9	18.5	ATS490D22Y	22	4	281	3.8/8.4
15	22	ATS490D32Y	32	8	405	5.8/12.8
18.5	30	ATS490D38Y	38	11	431	5.8/12.8
22	45	ATS490D47Y	47	17	560	5.8/12.8
30	55	ATS490D62Y	62	7	675	7/15.4
37	55	ATS490D75Y	75	11	914	7/15.4
45	75	ATS490D88Y	88	15	1,113	7/15.4
55	90	ATS490C11Y	110	32	1,471	7/15.4
75	110	ATS490C14Y	140	26	1,651	9.5/20.9
90	132	ATS490C17Y	170	38	2,101	9.5/20.9
110	160	ATS490C21Y	210	48	2,725	19/41.9
132	220	ATS490C25Y	250	64	3,034	19/41.9
160	250	ATS490C32Y	320	60	4,326	19/41.9
220	315	ATS490C41Y	410	99	5,480	19/41.9
250	355	ATS490C48Y	480	108	6,212	28/61.7
–	400	ATS490C59Y	590	164	7,847	28/61.7
315	500	ATS490C66Y	660	205	9,247	28/61.7
355	630	ATS490C79Y ▲	790	157	10,630	65/143
–	710	ATS490M10Y ▲	1,000	251	13,619	65/143
500	–	ATS490M12Y ▲	1,200	361	18,724	65/143
Heavy duty applications						
5.5	11	ATS490D17Y	12	–	–	3.8/8.4
7.5	15	ATS490D22Y	17	2	202	3.8/8.4
9	18.5	ATS490D32Y	22	4	281	5.8/12.8
15	22	ATS490D38Y	32	8	405	5.8/12.8
18.5	30	ATS490D47Y	38	11	431	5.8/12.8
22	45	ATS490D62Y	47	4	560	7/15.4
30	55	ATS490D75Y	62	7	675	7/15.4
37	55	ATS490D88Y	75	11	914	7/15.4
45	75	ATS490C11Y	88	15	1,113	7/15.4
55	90	ATS490C14Y	110	16	1,471	9.5/20.9
75	110	ATS490C17Y	140	26	1,651	9.5/20.9
90	132	ATS490C21Y	170	31	2,101	19/41.9
110	160	ATS490C25Y	210	45	2,725	19/41.9
132	220	ATS490C32Y	250	37	3,034	19/41.9
160	250	ATS490C41Y	320	60	4,326	19/41.9
220	315	ATS490C48Y	410	79	5,480	28/61.7
250	355	ATS490C59Y	480	108	6,212	28/61.7
–	400	ATS490C66Y	590	164	7,847	28/61.7
315	500	ATS490C79Y ▲	660	109	9,247	65/143
355	630	ATS490M10Y ▲	790	156	10,630	65/143
–	710	ATS490M12Y ▲	1,045	251	13,619	65/143

▲ Available Q2 2025

ATS490_SIZE_3_Default



ATS490C25Y

ATS490 in-line								
Motor nameplate				ATS490				
Rated operational voltage (Ue) Rated motor power				Reference	Operational rated current (Ie)	Power loss at Ie	Power loss during starting at 4Ie	Weight
208 V HP	230 V HP	460 V HP	575 V HP					
Normal duty applications								
3	5	10	15	ATS490D17Y	17	2	202	3.8/8.4
5	7.5	15	20	ATS490D22Y	22	4	281	3.8/8.4
7.5	10	20	25	ATS490D32Y	32	8	405	5.8/12.8
10	–	25	30	ATS490D38Y	38	11	431	5.8/12.8
–	15	30	40	ATS490D47Y	47	17	560	5.8/12.8
15	20	40	50	ATS490D62Y	62	7	675	7/15.4
20	25	50	60	ATS490D75Y	75	11	914	7/15.4
25	30	60	75	ATS490D88Y	88	15	1,113	7/15.4
30	40	75	100	ATS490C11Y	110	32	1,471	7/15.4
40	50	100	125	ATS490C14Y	140	26	1,651	9.5/20.9
50	60	125	150	ATS490C17Y	170	38	2,101	9.5/20.9
60	75	150	200	ATS490C21Y	210	48	2,725	19/41.9
75	100	200	250	ATS490C25Y	250	64	3,034	19/41.9
100	125	250	300	ATS490C32Y	320	60	4,326	19/41.9
125	150	300	350	ATS490C41Y	410	99	5,480	19/41.9
150	–	350	400	ATS490C48Y	480	108	6,212	28/61.7
–	200	400	500	ATS490C59Y	590	164	7,847	28/61.7
200	250	500	600	ATS490C66Y	660	205	9,247	28/61.7
250	300	600	800	ATS490C79Y ▲	790	157	10,630	65/143
350	350	800	1,000	ATS490M10Y ▲	1,000	251	13,619	65/143
400	450	1,000	1,200	ATS490M12Y ▲	1,200	361	18,724	65/143
Heavy duty applications								
2	3	7.5	10	ATS490D17Y	12	–	–	3.8/8.4
3	5	10	15	ATS490D22Y	17	2	202	3.8/8.4
5	7.5	15	20	ATS490D32Y	22	4	281	5.8/12.8
7.5	10	20	25	ATS490D38Y	32	8	405	5.8/12.8
10	–	25	30	ATS490D47Y	38	11	431	5.8/12.8
–	15	30	40	ATS490D62Y	47	4	560	7/15.4
15	20	40	50	ATS490D75Y	62	7	675	7/15.4
20	25	50	60	ATS490D88Y	75	11	914	7/15.4
25	30	60	75	ATS490C11Y	88	15	1,113	7/15.4
30	40	75	100	ATS490C14Y	110	16	1,471	9.5/20.9
40	50	100	125	ATS490C17Y	140	26	1,651	9.5/20.9
50	60	125	150	ATS490C21Y	170	31	2,101	19/41.9
60	75	150	200	ATS490C25Y	210	45	2,725	19/41.9
75	100	200	250	ATS490C32Y	250	37	3,034	19/41.9
100	125	250	300	ATS490C41Y	320	60	4,326	19/41.9
125	150	300	350	ATS490C48Y	410	79	5,480	28/61.7
150	–	350	400	ATS490C59Y	480	108	6,212	28/61.7
–	200	400	500	ATS490C66Y	590	164	7,847	28/61.7
200	250	500	600	ATS490C79Y ▲	660	109	9,247	65/143
250	300	600	800	ATS490M10Y ▲	790	156	10,630	65/143
350	350	800	1,000	ATS490M12Y ▲	1,045	251	13,619	65/143

▲ Available Q2 2025

Altivar Soft Starter ATS490

Soft starters for asynchronous motors

Replacement parts

ATS490_top_FAN_C21-DB8_Default



VZ3V4903

Replacement parts			
Description	Corresponding soft starter	Reference	Weight
			kg/lb
Fan kit + instruction sheet	ATS490D88Y...C17Y	VZ3V4902	0.125/0.276
	ATS490C21Y...C66Y	VZ3V4903	0.275/0.606
	ATS490C79Y...M12Y	VZ3V4904	1.7/3.748
Control block + instruction sheet	All ATS490 soft starters	VX4G4901	0.390/0.860

PF140389



Graphic display terminal VW3A1111

ATV340_63441_CP_SCT10025



Detected fault: The red screen backlight is activated automatically

PF140357



Embedded dynamic QR codes for contextual, instantaneous access to online help

PF140358



Scanning the QR code from a smartphone or tablet

PF140359



Instant access to online help

Graphic display terminal

This terminal can be:

- Connected and mounted on an enclosure door using a remote-mounting accessory
- Connected to a PC to exchange files via a Mini USB/USB connection (1)
- Connected to several soft starters and drives in multidrop mode (see page 30)

This terminal is used to:

- Control, adjust, and configure the soft starter
- Display current values (motor, I/O, and machine data)
- Store and download configurations (several configuration files can be stored in the 16 MB memory)
- Duplicate the configuration of one powered-up soft starter on another powered-up soft starter
- Copy configurations from a PC or soft starter and duplicate them on another soft starter (the soft starters should be powered up throughout the duplication operations)

Other characteristics:

- Up to 24 languages (complete alphabets) covering the majority of countries around the world
- Languages can be removed, added, and updated according to user needs
- The languages files are available from the Altivar Soft Starter ATS490 page on our website
- Simply connect the graphic display terminal to your computer USB port and using the Windows file manager copy/paste the selected languages files
- Two-color backlit display (white and red); if an error is detected, the red backlight is activated automatically (function can be disabled)
- Operating temperature range: $-15 \dots 60 \text{ }^\circ\text{C}$ / $5 \dots 140 \text{ }^\circ\text{F}$
- Degree of protection: IP65

Multipoint screen

The graphic display terminal is connected to one soft starter only. However, communication is possible between a graphic display terminal and several Altivar soft starters (ATS480, ATS490) and drives (ATV340, ATV600, and ATV900) connected on the same Modbus serial fieldbus via the RJ45 port (HMI or Modbus serial). In this case, multipoint mode is automatically applied to the graphic display terminal.

A maximum of 32 soft starters or drives can be connected on the same Modbus serial fieldbus.

Apart from the Stop function linked to the STOP/RESET key, multipoint mode cannot be used to apply a reset after an error has been detected or to control the soft starter via the graphic display terminal: in multipoint mode, the Run key and the Local/Remote key are disabled.

Description

Display:

- Eight lines, 240 x 160 pixels
- Displays bar charts, gages, and trend charts
- Four function keys to facilitate navigation and provide contextual links for enabling functions
- STOP/RESET button: Local control of motor stop command/clearing detected errors
- RUN button: Local control of motor run command
- Navigation buttons:
 - OK button: Stores the current value (ENT)
 - Turn \pm : Increases or decreases the value, goes to the next or previous line
 - ESC button: Aborts a value, parameter, or menu to return to the previous selection
 - Home: Root menu
 - Information (i): Contextual help

References

Description	Reference	Weight kg/ lb
Graphic display terminal	VW3A1111	0.200/ 0.441

(1) Graphic display terminal used as a handheld terminal only.

Altivar Soft Starter ATS490

Soft starters for asynchronous motors

Configuration and runtime tools

Accessories for graphic display terminal

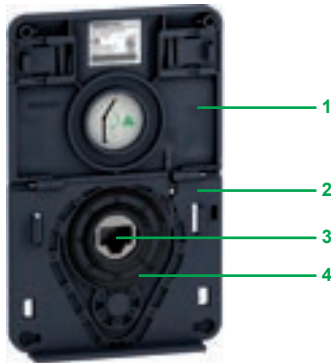

Remote-mounting kit for mounting graphic display terminal on enclosure door (front face)

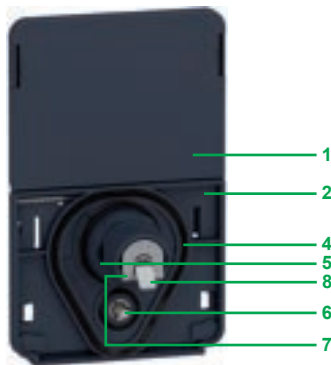

Remote-mounting kit for graphic display terminal (rear face)

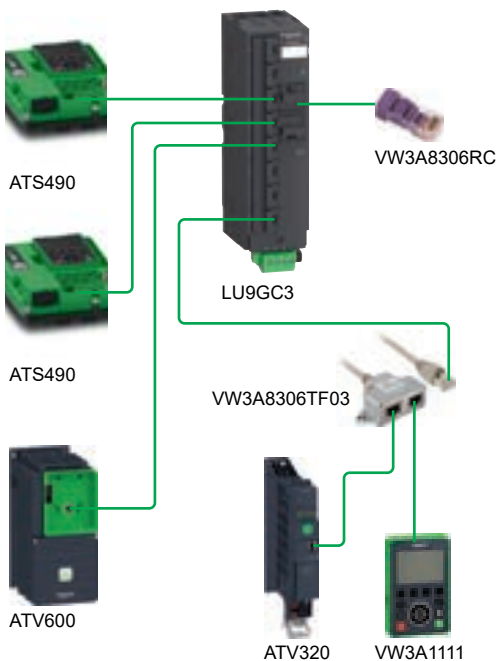

Example of multipoint screen architecture

Accessories for graphic display terminal

- Remote-mounting kit for mounting on enclosure door with IP65/UL Type 12 degree of protection as standard

The kit includes:

- Tightening tool (also sold separately under the reference ZB5AZ905)
- 1 Cover plate to maintain IP65 protection when there is no terminal connected
- 2 Mounting plate
- 3 RJ45 port for the graphic display terminal
- 4 Seal
- 5 Fixing nut
- 6 Anti-rotation pin
- 7 RJ45 port for connecting the remote-mounting cordset (10 m/32.8 ft maximum)
- 8 Grounding connector

Drilling a hole with a standard $\varnothing 22$ tool, as used for a pushbutton, allows the unit to be mounted without the need for a cut-out in the enclosure ($\varnothing 22.5$ mm/0.89 in. drill hole).

References

Description	Length m/ ft	IP rating	Reference	Weight kg/ lb
Remote-mounting kit Order with remote-mounting cordset VW3A1104R●●●	–	65/ UL Type 12	VW3A1112	–
Tightening tool for remote-mounting kit	–	–	ZB5AZ905	0.016/ 0.035
Remote-mounting cordset equipped with two RJ45 connectors	1/ 3.28	–	VW3A1104R10	0.050/ 0.110
	3/ 9.84	–	VW3A1104R30	0.150/ 0.331
	5/ 16.4	–	VW3A1104R50	0.250/ 0.551
	10/ 32.8	–	VW3A1104R100	0.500/ 1.102

USB/Mini B USB cable
for connecting the graphic display terminal to a PC

Multidrop connection accessories

These accessories are used to connect a graphic display terminal to several ATS490 soft starters via a multidrop link. This multidrop connection uses the RJ45 terminal port on the front of the Altivar Soft Starter ATS490.

Connection accessories

Description	Sold in lots of	Unit reference	Weight kg/ lb	
Modbus splitter box, 10 RJ45 connectors, and one screw terminal block	–	LU9GC3	0.500/ 1.102	
Modbus T-junction boxes	With 0.3 m/0.98 ft integrated cable	VW3A8306TF03	0.190/ 0.419	
	With 1 m/3.28 ft integrated cable	VW3A8306TF10	0.210/ 0.463	
Modbus line terminator	For RJ45 connector	R = 120 Ω C = 1 nf	VW3A8306RC	0.010/ 0.022
Cordsets (equipped with two RJ45 connectors)				
Used for	Length m/ ft	Reference	Weight kg/ lb	
Serial link	0.3/ 0.98	VW3A8306R03	0.025/ 0.055	
	1/ 3.28	VW3A8306R10	0.060/ 0.132	
	3/ 9.84	VW3A8306R30	0.130/ 0.287	



Altivar Soft Starter ATS490 DTM in EcoStruxure Control Expert

DTM

Presentation

Using FDT/DTM technology, it is possible to configure, control, and diagnose the Altivar Soft Starter ATS490 directly in EcoStruxure Control Expert and SoMove software by means of the same software brick (DTM).

FDT/DTM technology standardizes the communication interface between field devices and host systems. The DTM contains a uniform structure for managing soft starter access parameters.

Specific functions of Altivar Soft Starter ATS490

- Offline or online access to soft starter data
- Configuration and management of cybersecurity features
- Access to audit log file for cybersecurity threat intelligence
- Transfer of configuration files from and to the soft starter
- Customization
- Access to soft starter parameters and communication modules
- Graphic interface to assist with configuration of the ATS490 functions
- Detected error and warning logs (with timestamping)

Advantages of the DTM library in EcoStruxure Control Expert:

- Single tool for configuration, setup, and diagnostics
- Network scan for automatic recognition of network configuration
- Ability to add/remove, copy/paste configuration files from other soft starters in the same architecture
- Single input point for all parameters shared between the ePAC (programmable controller) and the Altivar Soft Starter ATS490
- Creation of profiles for implicit communication with the ePAC as well as dedicated profiles for programs with DFBs (derived function blocks)
- Integration in the fieldbus topology
- Soft starter configuration is an integral part of the EcoStruxure Control Expert project file (STU) and the archive file (STA)

Advantages of the DTM library in SoMove:

- Altivar-oriented software environment
- Wired connection to USB-A port or the Ethernet communication port
- Standard cable (file transfer performance)
- Third-party software and downloads:
 - The Altivar Soft Starter DTM library is a flexible, open, and interactive tool that can be used in a third-party FDT.
 - DTMs can be downloaded from our [website](#).
- Firmware update of the Altivar Soft Starter ATS490



SoMove software

SoMove software

SoMove software for PC is used to configure, set up, maintain, and upgrade the firmware (see [page 39](#)) of the Altivar Soft Starter ATS490.

The software can be connected to the Altivar Soft Starter ATS490 via:

- Modbus connection
- Ethernet Modbus TCP connection
- CANopen (1)

For more information on SoMove setup software, please consult the [SoMove Setup Software catalog](#).

(1) Requires an optional communication module (see [page 37](#))

Table showing possible combinations of accessories for ATS490

ATS490 reference	Protective covers for power terminals	Line chokes
ATS490D17Y	-	VZ1L015UM17T
ATS490D22Y	-	VZ1L030U800T
ATS490D32Y	-	VZ1L040U600T
ATS490D38Y	-	VZ1L040U600T
ATS490D47Y	-	VZ1L070U350T
ATS490D62Y	-	VZ1L070U350T
ATS490D75Y	-	VZ1L150U170T
ATS490D88Y	-	VZ1L150U170T
ATS490C11Y	-	VZ1L150U170T
ATS490C14Y	VW3G4701	VZ1L150U170T
ATS490C17Y	VW3G4701	VZ1L250U100T
ATS490C21Y	VW3G4702	VZ1L250U100T
ATS490C25Y	VW3G4702	VZ1L250U100T
ATS490C32Y	VW3G4702	VZ1L325U075T
ATS490C41Y	VW3G4702	VZ1L530U045T
ATS490C48Y	VW3G4703	VZ1L530U045T
ATS490C59Y	VW3G4703	VZ1LM10U024T
ATS490C66Y	VW3G4703	VZ1LM10U024T
ATS490C79Y	-	VZ1LM10U024T
ATS490M10Y	-	VZ1LM10U024T
ATS490M12Y	-	VZ1LM14U016T

List of communication modules

Description	Reference
CANopen daisy chain	VW3A3608
CANopen SUB-D	VW3A3618
CANopen screw terminal block	VW3A3628
PROFIBUS DP V1	VW3A3607

Altivar Soft Starter ATS490

Soft starters for asynchronous motors

Communication buses

Description, functions

Description

The Altivar Soft Starter ATS490 range has been designed to simplify connections to communication buses by means of the following:

- 1 Integrated RJ45 communication port for HMI on the front
- 2 Integrated RJ45 communication port for Modbus fieldbus
- 3 Integrated RJ45 communication port for Ethernet Modbus TCP and EtherNet/IP
- 4 Slot available for an additional communication module

Functions

Altivar Soft Starter ATS490 functions can be accessed via the communication buses:

- Control
- Monitoring
- Condition monitoring
- Adjustment
- Configuration

The command may come from different sources:

- Digital input or analog I/O terminals
- Communication bus
- Remote/local display terminals

As one of the advanced functions, ATS490 control sources can be managed and switched according to the application requirements.

The communication periodic I/O data assignment can be selected using the communication bus configuration software.

Communication is monitored according to criteria specific to each protocol. Regardless of protocol type, the response of the soft starter to a detected communication interruption can be configured as follows:

- Freewheel stop, stop on ramp, or braked stop
- Ignore the detected error and maintain the last command received

Integrated communication protocols

The Altivar Soft Starter ATS490 integrates EtherNet/IP, Modbus TCP, and Modbus serial link communication protocols as standard:

- EtherNet/IP and Modbus TCP protocols offer standard services regularly used in industrial networks:
 - EtherNet/IP adapter including standard CIP objects, compliant with ODVA specification.
 - Modbus TCP message handling is based on the Modbus protocol and is used to exchange process data with other network devices (e.g. a controller). It provides the ATS490 with access to the Modbus protocol and the high performance of the Ethernet network, which is the communication standard for numerous devices.
 - SNMP (Simple Network Management Protocol) offers standard diagnostics services for network management tools.
 - The FDR (Fast Device Replacement) service allows automatic reconfiguration of a new device installed to replace an existing device.
 - Device integrity is reinforced by disabling some unused services as well as managing a list of authorized people and devices.
 - Setup and adjustment tools (SoMove, EcoStruxure Control Expert with DTM) can be connected locally or remotely.
 - The embedded Web server is used to display operating data and dashboards as well as to configure and perform system elements diagnostics from any Web browser.

These numerous services offered by the ATS490 simplify integration into Schneider Electric automation control systems.

- Serial port
 - Field network operation for exchanging data with other devices via the Modbus protocol
 - Multidrop connection of the following HMIs and configuration tools:
 - The graphic display terminal supplied with the drive
 - A Harmony industrial HMI terminal
 - A PC with SoMove or EcoStruxure Control Expert setup software

The detailed specifications for the EtherNet/IP or serial communication ports and the Modbus and Modbus TCP protocols are available on our website.

Altivar Soft Starter ATS490

Soft starters for asynchronous motors

Communication buses

Integrated communication protocols

Integrated communication protocols (continued)

EtherNet/IP and Modbus TCP port connection accessories

Description (2)	Item	Length m/ft	Reference
Straight shielded twisted pair cables (2) equipped with two RJ45 connectors conforming to EIA/TIA-568 category 5 and IEC 11801/EN 50173-1, class D	1	2/6.56	490NTW00002
		5/16	490NTW00005
		12/39	490NTW00012
Crossover shielded twisted pair cables equipped with two RJ45 connectors conforming to EIA/TIA-568 category 5 and IEC 11801/EN 50173-1, class D	2	5/16	490NTC00005
Straight shielded twisted pair cables equipped with two RJ45 connectors conforming to UL and CSA 22.1	1	2/6.56	490NTW00002U
		5/16	490NTW00005U
		12/39	490NTW00012U

(1) Please refer to the [Modicon catalogs](#).

(2) Also exist in 40 and 80 m/131 and 262 ft lengths. For other ConneXium connection accessories, please refer to the [Modicon Networking catalog](#).

Modbus serial link connection accessories

Description	Item	Length m/ft	Reference
Modbus splitter box 10 RJ45 connectors and one screw terminal block	3	–	LU9GC3
Cordsets for Modbus serial link equipped with two RJ45 connectors	4	0.3/0.98	VW3A8306R03
		1/3.28	VW3A8306R10
		3/9.84	VW3A8306R30
Modbus T-junction boxes (with integrated cable)	6	0.3/0.98	VW3A8306TF03
		1/3.28	VW3A8306TF10
Modbus line terminator for RJ45 connector (4)	5	R = 120 Ω	VW3A8306RC
		R = 150 Ω	VW3A8306R

(3) Please consult the [PLC, PAC and Dedicated Controllers](#) page on our website.

(4) Sold in lots of two.

(5) Cable depends on the controller.



VW3A3608



VW3A3618

Controller (1)



CANopen bus (2)

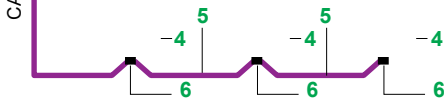

Altivar Soft Starter ATS490 + VW3A3618 module

Example of connection to the CANopen bus via SUB-D connector

CANopen bus

Description	Item	Length m/ft	Reference
Communication module			
CANopen daisy chain module Ports: Two RJ45 connectors	1	–	VW3A3608
Connection to RJ45 accessories (optimized solution for daisy chain connection on CANopen bus)			
CANopen cordsets equipped with two RJ45 connectors	2	0.3/0.98 1/3.28	VW3CANCARR03 VW3CANCARR1
CANopen line terminator for RJ45 connector	3	–	TCSCAR013M120
CANopen junction box Two IP20 tap junctions, two RJ45 connectors	–	–	VW3CANTAP2
Communication module			
CANopen SUB-D module Ports: One 9-way male SUB-D connector	4	–	VW3A3618
Connection accessories			
CANopen cables (2) (3) Standard cable, C€ mark Low smoke zero halogen Flame-retardant (IEC 60332-1)	5	50/164 100/328 300/984	TSXCANCA50 TSXCANCA100 TSXCANCA300
CANopen cables (2) (3) UL certification, C€ mark Flame-retardant (IEC 60332-2)	5	50/164 100/328 300/984	TSXCANCB50 TSXCANCB100 TSXCANCB300
CANopen cables (2) (3) Cable for harsh environments or mobile installations, C€ mark Low smoke zero halogen Flame-retardant (IEC 60332-1)	5	50/164 100/328 300/984	TSXCANCD50 TSXCANCD100 TSXCANCD300
IP20 straight CANopen connector (4) 9-way female SUB-D connector with line terminator that can be deactivated For connecting CAN-H, CAN-L, CAN-GND	6	–	TSXCANKCDF180T

(1) Please consult the [PLC, PAC and Dedicated Controllers](#) page on our website.

(2) Cable depends on the controller, please refer to the [CANopen for machines](#) catalog.

(3) Standard environment:

- No particular environmental constraints
- Operating temperature between 5 and 60 °C/41 and 140 °F
- Fixed installation

Harsh environment:

- Resistance to hydrocarbons, industrial oils, detergents, solder splashes
- Relative humidity up to 100%
- Saline atmosphere
- Operating temperature between -10 and +70 °C/+14 and 158 °F
- Significant temperature variations

(4) Only straight connectors are compatible with the Altivar Soft Starter ATS490.

Altivar Soft Starter ATS490

Soft starters for asynchronous motors

Communication buses

Options: Communication modules

LXM92_CP21043



VW3A3628

Controller (1)



CANopen bus (2)

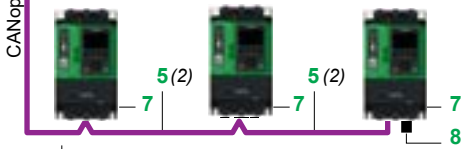

Altivar Soft Starter ATS490 + VW3A3628 module
Example of connection to the CANopen bus with a screw terminal block

PF095130



VW3A3607

CANopen bus (continued)

Description	Item	Length m/ft	Reference
Communication module			
CANopen module Port: One 5-way screw terminal block	7	–	VW3A3628
Connection accessories			
CANopen IP20 cordsets equipped with two 9-way female SUB-D connectors Standard cable, CE mark. Low smoke zero halogen Flame-retardant (IEC 60332-1)	–	0.3/0.98	TSXCANCADD03
	–	1/3.28	TSXCANCADD1
	–	3/9.84	TSXCANCBDD3
	–	5/16.4	TSXCANCBDD5
IP20 CANopen tap junction boxes equipped with: ■ Four 9-way male SUB-D connectors + screw terminal block for trunk cable tap link ■ Line terminator	–	–	TSXCANTDM4
CANopen line terminator for screw terminal connector (3)	8	–	TCSCAR01NM120

PROFIBUS DP V1 bus (4)

Description	Reference
Communication module	
PROFIBUS DP V1 module Port: One 9-way female SUB-D connector Conforming to PROFIBUS DP V1 Offers several message handling modes based on DP V1	VW3A3607
Connection accessories	
Profibus DP connector IP20 straight connectors (5)	LU9AD7

(1) Please refer to the [Modicon catalogs](#).
 (2) Refer to the connection to SUB-D connector cable selection table on the previous page.
 (3) Sold in lots of two.
 (4) Minimum version compatible with Altivar Soft Starters ATS490: V1.16.
 (5) Only straight connectors are compatible with Altivar Soft Starters ATS490.



Firmware update through Modbus TCP/Ethernet/IP or Modbus serial using SoMove



Firmware upload of several ATS490 soft starters at the same time through Modbus TCP/EtherNet/IP or Modbus serial using Ecostruxure Automation Device Maintenance

Firmware update using SoMove or EcoStruxure Automation Device Maintenance

Presentation

The firmware of the Altivar Soft Starter ATS490 offer can be updated.

This includes:

- The firmware of the ATS490 product
- The firmware of the graphic display terminals (1)
- The firmware of communication modules (1)
- The firmware of the embedded Web server
- The firmware of the embedded Modbus TCP and EtherNet/IP

The firmware and languages are available from the [Altivar Soft Starter ATS490 page on our website](#). Using the Schneider Electric Software Update tool, notifications are automatically sent when new updates are available.

Firmware update process

There are different ways to update the firmware:

- Single product firmware update using SoMove software (2)
- Multiple product firmware update using EcoStruxure Automation Device Maintenance (3)

The update process comprises two steps:

- The first step is to transfer the firmware to the product, which can be performed when the motor is either running or stopped. The control section of the ATS490 must be powered on. The product firmware package can be uploaded in one operation via the Modbus serial port, or the Modbus TCP and EtherNet/IP port.
- The second step is to apply the uploaded firmware in the products: the control section must be powered on and this operation can only be performed with the motor stopped. The firmware can be applied from EcoStruxure Automation Device Maintenance, SoMove, or the graphic display terminal.

This two-step process avoids the risk of a potential loss of usability of the product in case of incorrect operations during the firmware update process, while also reducing the amount of time the motor is stopped.

Cybersecurity-related features in the firmware update:

- The firmware is delivered with a digital certificate that is generated by a cryptographic key.
- The ATS490 checks the authenticity of the firmware before applying it. The authenticity of the firmware is also checked at each power-up.
- The firmware can only be updated and applied by a registered user with a valid user account and associated rights.
- Firmware update operations are recorded as events in the security-related reports.

(1) Contact Schneider Electric Services to update the firmware of the PROFIBUS DP communication module or the graphic display terminal.

(2) Refer to [page 32](#).

(3) Download EcoStruxure Automation Device Maintenance from its [dedicated page on our website](#).

Firmware update using SoMove or EcoStruxure Automation Device Maintenance (continued)		
Connection accessories		
Description	Length m/ft	Reference
High-speed USB-A/RJ45 flashing cordset For connection between PC and soft starter Modbus serial port	2.5/8.2	VW3A8127
Connection cable USB/RJ45 For connection between PC and soft starter Modbus serial port	2.5/8.2	TCSMCNAM3M002P
RJ45 female/female adapter For connection to plain text display terminal	–	VW3A1105
Straight shielded twisted pair cables (2) equipped with two RJ45 connectors conforming to EIA/TIA-568 category 5 and IEC 11801/EN 50173-1, class D	2/6.56	490NTW00002
	5/16	490NTW00005
	12/39	490NTW00012
Straight shielded twisted pair cables equipped with two RJ45 connectors conforming to UL and CSA 22.1	2/6.56	490NTW00002U
	5/16	490NTW00005U
	12/39	490NTW00012U

Altivar Soft Starter ATS490

Soft starters for asynchronous motors

Options: Line chokes, protective covers for power terminals



F_19_ACCESSORIES_CPODA2016006
VZ1L150U170T

Line chokes

The use of line chokes is recommended in particular when installing several soft starters on the same line supply to limit low frequency interference that may affect low level loads.

The inductance values are defined for a voltage drop between 3% and 5% of the nominal line voltage.

Install the line choke between the line contactor and the soft starter.

References

Corresponding soft starter	Line choke			Reference	Weight kg/ lb
	Inductance value mH	Nominal current A	Degree of protection		
ATS490D17Y	1.7	15	IP20	VZ1L015UM17T	2.1/ 4.63
ATS490D22Y	0.8	30	IP20	VZ1L030U800T	4.1/ 9.04
ATS490D32Y...D38Y	0.6	40	IP20	VZ1L040U600T	5.1/ 11.2
ATS490D47Y...D62Y	0.35	70	IP20	VZ1L070U350T	8/ 17.6
ATS490D75Y...C14Y	0.17	150	IP00	VZ1L150U170T	14.9/ 32.8
ATS490C17Y...C25Y	0.1	250	IP00	VZ1L250U100T	24.3/ 53.5
ATS490C32Y	0.075	325	IP00	VZ1L325U075T	28.9/ 63.7
ATS490C41Y...C48Y	0.045	530	IP00	VZ1L530U045T	37/ 81.5
ATS490C59Y...M10Y	0.024	1,025	IP00	VZ1LM10U024T	66/ 145.5
ATS490M12Y	0.016	1,435	IP00	VZ1LM14U016T	80/ 176.3

Protective covers for power terminals

The protective covers are intended to be mounted on 140 to 660 A soft starters that have unprotected power terminals. The protective covers provide an IP20 protection degree.

References

Corresponding soft starter	Number of covers per set	Reference	Weight kg/ lb
ATS490C14Y...C17Y	6	VW3G4701	0.2/ 0.44
ATS490C21Y...C41Y	6	VW3G4702	0.6/ 1.32
ATS490C48Y...C66Y	6	VW3G4703	0.7/ 1.54

For ATS490C79Y and above, plan to make a protective screen to be attached to the front of the product. Refer to the [ATS490 user manual](#).



ATS490_SZ_COVER_Default
VW3G4701

Altivar Soft Starter ATS490

Soft starters for asynchronous motors

Type of coordination, variants on the wiring diagram

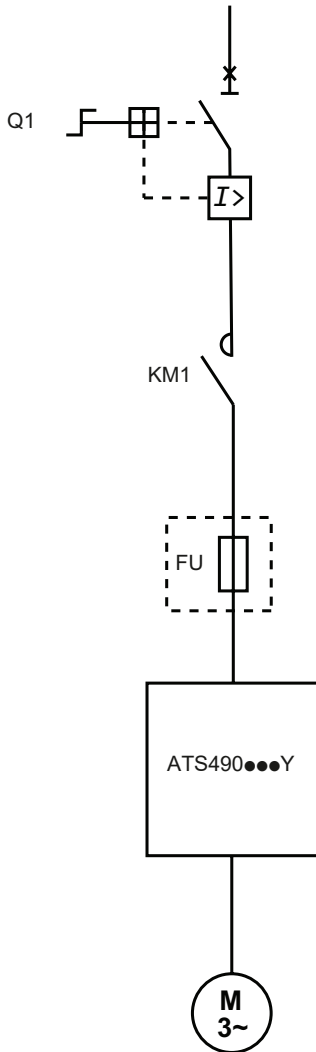

Presentation

Type of coordination

The EN/IEC 60947-4-2 standard makes a distinction between two different types of coordination: type 1 coordination and type 2 coordination:

- Type 1 coordination requires that, under short-circuit conditions, the contactor or soft starter shall cause no danger to persons or the installation and may not be suitable for further service without repair and replacement of parts.
- Type 2 coordination requires that, under short-circuit conditions, the contactor or soft starter shall cause no danger to persons or the installation and shall be suitable for further use. The risk of contact welding is recognized, in which case the manufacturer shall indicate the measures to be taken as regards the maintenance of the equipment.
- For type 2 coordination (according to IEC 60947-4-2), fast-acting fuses must be installed in series with the soft starter to provide protection for the ATS490 in the event of a short circuit. After a short circuit, the fast-acting fuses must be replaced, and the contactor must be checked.

Note: Use of a short-circuit protection device (SCPD) that does not comply with the manufacturer's specification can invalidate the coordination.

Line contactor

The line contactor on the ATS490 is optional. The ATS490 integrates a Safe Torque Off function that is certified IEC 61508 Safety Integrity Level 1, that brings the machine or functional unit to a no-torque state and/or prevents it from starting accidentally. The operator can intervene on the mechanical part of the application without switching off the electrical power supply.

When used, the line contactor is controlled by relay R1. There are two possibilities influencing the wiring diagram:

- R1 assigned to "Operating State Fault":
 - The line contactor is controlled by the Power ON and Power OFF push buttons and relay R1. Relay R1 is activated when the soft starter is powered up (minimum A1/A2 control) and is deactivated when an error is detected and the motor switches to freewheel mode.
- R1 assigned to "Line Contactor":
 - The line contactor is controlled by relay R1 on the basis of the ATS490 RUN and STOP commands. Relay R1 is activated by a RUN command (or a preheating command). It is deactivated at the end of braking or deceleration, or when the motor switches to freewheel mode after a STOP command. It is also deactivated when an error is detected: the motor switches to freewheel mode at this point.

Thermal monitoring

The Altivar Soft Starter ATS490 will help to protect the motor and the cables against overloads using either the embedded electronic overload relay or embedded motor thermal protection when PTC, PT100, PT1000, or KTY probes are connected to the ATS490. If these monitoring functions are disabled, external thermal monitoring must be provided.

230 V power supply, ATS490 connected in-line					
Motor power kW	Combination Iq (kA)	ATS490 reference		Circuit breaker (1) Q1 reference	Optional line contactor (2) KM1 reference
		Class 10 Normal duty	Class 20 Heavy duty		
3	50	–	ATS490D17Y	GV2L20	LC1D18●●
4	50	ATS490D17Y	ATS490D22Y	GV2L20	LC1D18●●
5.5	50	ATS490D22Y	ATS490D32Y	GV2L22	LC1D25●●
7.5	50	ATS490D32Y	ATS490D38Y	GV2L32	LC1D32●●
9	50	ATS490D38Y	ATS490D47Y	GV3L40	LC1D38●●
11	50	ATS490D47Y	ATS490D62Y	GV3L65	LC1D50A●●
15	50	ATS490D62Y	ATS490D75Y	GV3L65	LC1D65A●●
18.5	50	ATS490D75Y	ATS490D88Y	GV4L80B	LC1D80●●
22	50	ATS490D88Y	ATS490C11Y	GV4L115B	LC1D115●●
30	50	ATS490C11Y	ATS490C14Y	GV4L115B	LC1D115●●
37	50	ATS490C14Y	ATS490C17Y	NSX160F MA	LC1D150●●
45	50	ATS490C17Y	ATS490C21Y	NSX250F MA	LC1G185●●●●
55	50	ATS490C21Y	ATS490C25Y	NSX250F MA	LC1G225●●●●
75	50	ATS490C25Y	ATS490C32Y	NSX400N MicroLogic 1.3 M	LC1G265●●●●
90	50	ATS490C32Y	ATS490C41Y	NSX400N MicroLogic 1.3 M	LC1G330●●●●
110	70	ATS490C41Y	ATS490C48Y	NSX630N MicroLogic 1.3 M	LC1G400●●●●
132	70	ATS490C48Y	ATS490C59Y	NSX630N MicroLogic 1.3 M	LC1G500●●●●
160	70	ATS490C59Y	ATS490C66Y	NS630bN MicroLogic 5.0 LR Off	LC1G630●●●●
200	70	ATS490C66Y	ATS490C79Y	NS800N MicroLogic 5.0 LR Off	LC1G630●●●●
220	70	ATS490C79Y	ATS490M10Y	NS800N MicroLogic 5.0 LR Off	LC1G800●●●●
250	70	ATS490M10Y	ATS490M12Y	NS1000N MicroLogic 5.0 LR Off	LC1F1000●●
355	42	ATS490M12Y	–	NS1250N MicroLogic 5.0 LR Off	LC1F2600●●

230 V power supply, ATS490 connected inside motor delta					
Motor power kW	Combination Iq (kA)	ATS490 reference		Circuit breaker (1) Q1 reference	Optional line contactor (2) KM1 reference
		Class 10 Normal duty	Class 20 Heavy duty		
5.5	50	–	ATS490D17Y	GV2L22	LC1D25●●
7.5	50	ATS490D17Y	ATS490D22Y	GV2L32	LC1D32●●
9	50	ATS490D22Y	ATS490D32Y	GV3L40	LC1D38●●
15	50	ATS490D32Y	ATS490D38Y	GV3L65	LC1D65A●●
18.5	50	ATS490D38Y	ATS490D47Y	GV4L80B	LC1D80●●
22	50	ATS490D47Y	ATS490D62Y	GV4L115B	LC1D115●●
30	50	ATS490D62Y	ATS490D75Y	GV4L115B	LC1D115●●
37	50	ATS490D75Y	ATS490D88Y	NSX160F MA	LC1D150●●
45	50	ATS490D88Y	ATS490C11Y	NSX250F MA	LC1G185●●●●
55	50	ATS490C11Y	ATS490C14Y	NSX250F MA	LC1G225●●●●
75	50	ATS490C14Y	ATS490C17Y	NSX400N MicroLogic 1.3 M	LC1G265●●●●
90	50	ATS490C17Y	ATS490C21Y	NSX400N MicroLogic 1.3 M	LC1G330●●●●
110	70	ATS490C21Y	ATS490C25Y	NSX630N MicroLogic 1.3 M	LC1G400●●●●
132	70	ATS490C25Y	ATS490C32Y	NSX630N MicroLogic 1.3 M	LC1G500●●●●
160	70	ATS490C32Y	ATS490C41Y	NS630bN MicroLogic 5.0 LR Off	LC1G630●●●●
220	70	ATS490C41Y	ATS490C48Y	NS800N MicroLogic 5.0 LR Off	LC1G800●●●●
250	70	ATS490C48Y	ATS490C59Y	NS1000N MicroLogic 5.0 LR Off	LC1F1000●●
315	42	ATS490C66Y	ATS490C79Y	NS1250N Micrologic 5,0 LR Off	LC1F2600●●
355	42	ATS490C79Y	ATS490M10Y	NS1250N MicroLogic 5.0 LR Off	LC1F2600●●

(1) Set I_{rm} current of the circuit breaker (when available) to a minimum of six times the current rating of the soft starter.

(2) Replace with the appropriate control circuit voltage code (refer to page 51).

380/400/415 V power supply, ATS490 connected in-line

Motor power kW	Combination Iq (kA)	ATS490 reference		Circuit breaker (1) Q1 reference	Optional line contactor (2) KM1 reference
		Class 10 Normal duty	Class 20 Heavy duty		
5.5	50	–	ATS490D17Y	GV2L20	LC1D18●●
7.5	50	ATS490D17Y	ATS490D22Y	GV2L20	LC1D18●●
11	50	ATS490D22Y	ATS490D32Y	GV2L22	LC1D25●●
15	50	ATS490D32Y	ATS490D38Y	GV2L32	LC1D32●●
18.5	50	ATS490D38Y	ATS490D47Y	GV3L40	LC1D38●●
22	50	ATS490D47Y	ATS490D62Y	GV3L65	LC1D50A●●
30	50	ATS490D62Y	ATS490D75Y	GV3L65	LC1D65A●●
37	50	ATS490D75Y	ATS490D88Y	GV4L80N	LC1D80●●
45	50	ATS490D88Y	ATS490C11Y	GV4L115N	LC1D115●●
55	50	ATS490C11Y	ATS490C14Y	GV4L115N	LC1D115●●
75	50	ATS490C14Y	ATS490C17Y	NSX160N MA	LC1D150●●
90	50	ATS490C17Y	ATS490C21Y	NSX250N MA	LC1G185●●●●
110	50	ATS490C21Y	ATS490C25Y	NSX250N MA	LC1G225●●●●
132	50	ATS490C25Y	ATS490C32Y	NSX400N MicroLogic 1.3 M	LC1G265●●●●
160	50	ATS490C32Y	ATS490C41Y	NSX400N MicroLogic 1.3 M	LC1G330●●●●
220	70	ATS490C41Y	ATS490C48Y	NSX630H MicroLogic 1.3 M	LC1G500●●●●
250	70	ATS490C48Y	ATS490C59Y	NSX630H MicroLogic 1.3 M	LC1G500●●●●
315	70	ATS490C59Y	ATS490C66Y	NS630bH MicroLogic 5.0 LR Off	LC1G630●●●●
355	70	ATS490C66Y	ATS490C79Y	NS800H MicroLogic 5.0 LR Off	LC1G630●●●●
400	70	ATS490C79Y	ATS490M10Y	NS800H MicroLogic 5.0 LR Off	LC1G800●●●●
500	70	ATS490M10Y	ATS490M12Y	NS1000H MicroLogic 5.0 LR Off	LC1F1000●●
630	42	ATS490M12Y	–	NS1250H MicroLogic 5.0 LR Off	LC1F2600●●

380/400/415 V power supply, ATS490 connected inside motor delta

Motor power kW	Combination Iq (kA)	ATS490		Circuit breaker (1) Q1 reference	Optional line contactor (2) KM1 reference
		Class 10 Normal duty	Class 20 Heavy duty		
11	50	–	ATS490D17Y	GV2L22	LC1D25●●
15	50	ATS490D17Y	ATS490D22Y	GV2L32	LC1D32●●
18.5	50	ATS490D22Y	ATS490D32Y	GV3L40	LC1D38●●
22	50	ATS490D32Y	ATS490D38Y	GV3L65	LC1D50A●●
30	50	ATS490D38Y	ATS490D47Y	GV3L65	LC1D65A●●
45	50	ATS490D47Y	ATS490D62Y	GV4L115N	LC1D115●●
55	50	ATS490D62Y	ATS490D75Y	GV4L115N	LC1D115●●
55	50	ATS490D75Y	ATS490D88Y	GV4L115N	LC1D115●●
75	50	ATS490D88Y	ATS490C11Y	NSX160N MA	LC1D150●●
90	50	ATS490C11Y	ATS490C14Y	NSX250N MA	LC1G185●●●●
110	50	ATS490C14Y	ATS490C17Y	NSX250N MA	LC1G225●●●●
132	50	ATS490C17Y	ATS490C21Y	NSX400N MicroLogic 1.3 M	LC1G265●●●●
160	50	ATS490C21Y	ATS490C25Y	NSX400N MicroLogic 1.3 M	LC1G330●●●●
220	70	ATS490C25Y	ATS490C32Y	NSX630H MicroLogic 1.3 M	LC1G500●●●●
250	70	ATS490C32Y	ATS490C41Y	NSX630H MicroLogic 1.3 M	LC1G500●●●●
315	70	ATS490C41Y	ATS490C48Y	NS630bH MicroLogic 5.0 LR Off	LC1G630●●●●
355	70	ATS490C48Y	ATS490C59Y	NS800H MicroLogic 5.0 LR Off	LC1G630●●●●
400	70	ATS490C59Y	ATS490C66Y	NS800H MicroLogic 5.0 LR Off	LC1G800●●●●
500	70	ATS490C66Y	ATS490C79Y	NS1000H MicroLogic 5.0 LR Off	LC1F1000●●
630	42	ATS490C79Y	ATS490M10Y	NS1250H MicroLogic 5.0 LR Off	LC1F2600●●

(1) Set I_{rm} current of the circuit breaker (when available) to a minimum of six times the current rating of the soft starter.

(2) Replace with the appropriate control circuit voltage code (refer to page 51).

440 V power supply, ATS490 connected in-line					
Motor power kW	Combination I _q (kA)	ATS490 reference		Circuit breaker (1) Q1 reference	Optional line contactor (2) KM1 reference
		Class 10 Normal duty	Class 20 Heavy duty		
5.5	50	–	ATS490D17Y	GV4L25N	LC1D12●●
7.5	50	ATS490D17Y	ATS490D22Y	GV4L25N	LC1D18●●
11	50	ATS490D22Y	ATS490D32Y	GV4L25N	LC1D25●●
15	50	ATS490D32Y	ATS490D38Y	GV4L50N	LC1D40A●●
18.5	50	ATS490D38Y	ATS490D47Y	GV4L50N	LC1D40A●●
22	50	ATS490D47Y	ATS490D62Y	GV4L50N	LC1D40A●●
30	50	ATS490D62Y	ATS490D75Y	GV4L80N	LC1D65A●●
37	50	ATS490D75Y	ATS490D88Y	GV4L80N	LC1D65A●●
45	50	ATS490D88Y	ATS490C11Y	GV4L80N	LC1D80●●
55	50	ATS490C11Y	ATS490C14Y	GV4L115N	LC1D115●●
75	50	ATS490C14Y	ATS490C17Y	NSX160N MA	LC1D150●●
90	50	ATS490C17Y	ATS490C21Y	NSX250N MA	LC1G150●●●●
110	50	ATS490C21Y	ATS490C25Y	NSX250N MA	LC1G185●●●●
132	50	ATS490C25Y	ATS490C32Y	NSX250N MA	LC1G225●●●●
160	50	ATS490C32Y	ATS490C41Y	NSX400H MicroLogic 1.3 M	LC1G265●●●●
220	70	ATS490C41Y	ATS490C48Y	NSX630S MicroLogic 1.3 M	LC1G400●●●●
250	70	ATS490C48Y	ATS490C59Y	NSX630S MicroLogic 1.3 M	LC1G400●●●●
355	70	ATS490C59Y	ATS490C66Y	NS630bL MicroLogic 5.0 LR Off	LC1G630●●●●
400	70	ATS490C66Y	ATS490C79Y	NS630bL MicroLogic 5.0 LR Off	LC1G630●●●●
500	70	ATS490C79Y	ATS490M10Y	NS800L MicroLogic 5.0 LR Off	LC1G800●●●●
630	70	ATS490M10Y	ATS490M12Y	NS1000L MicroLogic 5.0 LR Off	LC1F1000●●
710	42	ATS490M12Y	–	NS1250H MicroLogic 5.0 LR Off	LC1F2600●●

500 V power supply, ATS490 connected in-line					
Motor power kW	Combination I _q (kA)	ATS490 reference		Circuit breaker (1) Q1 reference	Optional line contactor (2) KM1 reference
		Class 10 Normal duty	Class 20 Heavy duty		
7.5	50	–	ATS490D17Y	NSX100H MA	LC1D40A●●
9	50	ATS490D17Y	ATS490D22Y	NSX100H MA	LC1D40A●●
11	50	ATS490D22Y	ATS490D32Y	NSX100H MA	LC1D40A●●
18.5	50	ATS490D32Y	ATS490D38Y	NSX100H MA	LC1D40A●●
22	50	ATS490D38Y	ATS490D47Y	NSX100H MA	LC1D50A●●
30	50	ATS490D47Y	ATS490D62Y	NSX100H MA	LC1D50A●●
37	50	ATS490D62Y	ATS490D75Y	NSX100H MA	LC1D65A●●
45	50	ATS490D75Y	ATS490D88Y	NSX100H MA	LC1D80●●
55	50	ATS490D88Y	ATS490C11Y	NSX100H MA	LC1D80●●
75	50	ATS490C11Y	ATS490C14Y	NSX160H MA	LC1D150●●
90	50	ATS490C14Y	ATS490C17Y	NSX160H MA	LC1D150●●
110	50	ATS490C17Y	ATS490C21Y	NSX250H MA	LC1G185●●●●
132	50	ATS490C21Y	ATS490C25Y	NSX250H MA	LC1G225●●●●
160	50	ATS490C25Y	ATS490C32Y	NSX400H MicroLogic 1.3 M	LC1G265●●●●
220	50	ATS490C32Y	ATS490C41Y	NSX630H MicroLogic 1.3 M	LC1G400●●●●
250	70	ATS490C41Y	ATS490C48Y	NSX630L MicroLogic 1.3 M	LC1G400●●●●
315	70	ATS490C48Y	ATS490C59Y	NSX630L MicroLogic 1.3 M	LC1G500●●●●
400	70	ATS490C59Y	ATS490C66Y	NS630bL MicroLogic 5.0 LR Off	LC1G800●●●●
450	70	ATS490C66Y	ATS490C79Y	NS800L MicroLogic 5.0 LR Off	LC1G800●●●●
500	42	ATS490C79Y	ATS490M10Y	NS800L MicroLogic 5.0 LR Off	LC1F2600●●
630	42	ATS490M10Y	ATS490M12Y	NS1000L MicroLogic 5.0 LR Off	LC1F2600●●
800	42	ATS490M12Y	–	NS1250H MicroLogic 5.0 LR Off	LC1F2600●●

(1) Set I_{rm} current of the circuit breaker (when available) to a minimum of six times the current rating of the soft starter.
(2) Replace with the appropriate control circuit voltage code (refer to page 51).

690 V power supply, ATS490 connected in-line					
Motor power kW	Combination I _q (kA)	ATS490 reference		Circuit breaker (1) Q1 reference	Optional line contactor (2) KM1 reference
		Class 10 Normal duty	Class 20 Heavy duty		
11	50	–	ATS490D17Y	NSX100HB1 MA	LC1D40A●●
15	50	ATS490D17Y	ATS490D22Y	NSX100HB1 MA	LC1D40A●●
18.5	50	ATS490D22Y	ATS490D32Y	NSX100HB1 MA	LC1D40A●●
22	50	ATS490D32Y	ATS490D38Y	NSX100HB1 MA	LC1D40A●●
30	50	ATS490D38Y	ATS490D47Y	NSX100HB1 MA	LC1D40A●●
37	50	ATS490D47Y	ATS490D62Y	NSX100HB1 MA	LC1D65A●●
45	50	ATS490D62Y	ATS490D75Y	NSX100HB1 MA	LC1D80●●
55	50	ATS490D75Y	ATS490D88Y	NSX100HB1 MA	LC1D115●●
75	50	ATS490D88Y	ATS490C11Y	NSX100HB1 MA	LC1D115●●
90	15	ATS490C11Y	ATS490C14Y	NSX250HB1 MA	LC1D150●●
110	15	ATS490C14Y	ATS490C17Y	NSX250HB1 MA	LC1D150●●
160	50	ATS490C17Y	ATS490C21Y	NSX250HB1 MA	LC1G225●●●●
200	50	ATS490C21Y	ATS490C25Y	NSX400HB1 MicroLogic 1.3 M	LC1G265●●●●
250	50	ATS490C25Y	ATS490C32Y	NSX400HB1 MicroLogic 1.3 M	LC1G330●●●●
315	50	ATS490C32Y	ATS490C41Y	NSX630HB1 MicroLogic 1.3 M	LC1G400●●●●
400	70	ATS490C41Y	ATS490C48Y	NSX630HB1 MicroLogic 1.3 M	LC1G630●●●●
500	70	ATS490C48Y	ATS490C59Y	NS630bLB MicroLogic 5.0 LR Off	LC1G630●●●●
560	70	ATS490C59Y	ATS490C66Y	NS630bLB MicroLogic 5.0 LR Off	LC1G800●●●●
630	42	ATS490C66Y	ATS490C79Y	NS800LB MicroLogic 5.0 LR Off	LC1F2600●●
710	42	ATS490C79Y	ATS490M10Y	NS800LB MicroLogic 5.0 LR Off	LC1F2600●●
900	42	ATS490M10Y	ATS490M12Y	NS1000H MicroLogic 5.0 LR Off	LC1F2600●●
950	42	ATS490M12Y	–	NS1250H MicroLogic 5.0 LR Off	LC1F2600●●

(1) Set I_{rm} current of the circuit breaker (when available) to a minimum of six times the current rating of the soft starter.
(2) Replace with the appropriate control circuit voltage code (refer to page 51).

230 V power supply, ATS490 connected in-line								
Motor power kW	I _q (kA)	ATS490		Circuit breaker (1) Q1 reference	Optional line contactor KM1 reference	Fast-acting fuses with microswitch FU reference		Fuse disconnecter Reference
		Class 10 Normal duty	Class 20 Heavy duty			Size		
3	50	–	ATS490D17Y	GV2L20	LC1D25●●	DF3ER50	14 x 51	GK1EK
4	50	ATS490D17Y	ATS490D22Y	GV2L20	LC1D25●●	DF3ER50	14 x 51	GK1EK
5.5	50	ATS490D22Y	ATS490D32Y	GV2L22	LC1D25●●	DF3FR80	22 x 58	GS1JD3
7.5	50	ATS490D32Y	ATS490D38Y	GV2L32 + GV1L3	LC1D32●●	DF3FR80	22 x 58	GS1JD3
9	35	ATS490D38Y	ATS490D47Y	GV3L40	LC1D80●●	DF3FR100	22 x 58	GS1JD3
11	35	ATS490D47Y	ATS490D62Y	GV3L65	LC1D80●●	DF3FR100	22 x 58	GS1JD3
15	50	ATS490D62Y	ATS490D75Y	GV4L80B	LC1D65A●●	DF400125	00	GS1KKD3
18.5	50	ATS490D75Y	ATS490D88Y	GV4L80B	LC1D80●●	DF400125	00	GS1KKD3
22	50	ATS490D88Y	ATS490C11Y	GV4L115B	LC1D115●●	DF400160	00	GS1LLD3
30	50	ATS490C11Y	ATS490C14Y	GV4L115B	LC1D115●●	DF400160	00	–
37	50	ATS490C14Y	ATS490C17Y	NSX160F MA	LC1D150●●	DF430400	30	–
45	50	ATS490C17Y	ATS490C21Y	NSX250F MA	LC1G185●●●●	DF430400	30	–
55	50	ATS490C21Y	ATS490C25Y	NSX250F MA	LC1G225●●●●	–	–	–
75	50	ATS490C25Y	ATS490C32Y	NSX400F MicroLogic 1.3 M	LC1G265●●●●	DF431700	31	–
90	50	ATS490C32Y	ATS490C41Y	NSX400F MicroLogic 1.3 M	LC1G330●●●●	DF431700	31	–
110	50	ATS490C41Y	ATS490C48Y	NSX630F MicroLogic 1.3 M	LC1G400●●●●	DF433800	33	–
132	50	ATS490C48Y	ATS490C59Y	NSX630F MicroLogic 1.3 M	LC1G500●●●●	–	–	–
160	50	ATS490C59Y	ATS490C66Y	NS630bN MicroLogic 5.0 LR Off	LC1G630●●●●	–	–	–
200	50	ATS490C66Y	ATS490C79Y	NS800N MicroLogic 5.0 LR Off	LC1G630●●●●	–	–	–
220	50	ATS490C79Y	ATS490M10Y	NS800N MicroLogic 5.0 LR Off	LC1G800●●●●	DF4441600	44	–
250	85	ATS490M10Y	ATS490M12Y	NS1000N MicroLogic 5.0 LR Off	LC1F1000●●	DF4442200	44	–
355	50	ATS490M12Y	–	NS1250N MicroLogic 5.0 LR Off	LC1F2600●● (3)	DF4442200	44	–

230 V power supply, ATS490 connected inside motor delta								
Motor power kW	I _q (kA)	ATS490		Circuit breaker (1) Q1 reference	Optional line contactor KM1 reference	Fast-acting fuses with microswitch FU reference		Fuse disconnecter Reference
		Class 10 Normal duty	Class 20 Heavy duty			Size		
5.5	50	–	ATS490D17Y	GV2L22	LC1D25●●	DF3ER50	14 x 51	GK1EK
7.5	50	ATS490D17Y	ATS490D22Y	GV2L32 + GV1L3	LC1D32●●	DF3ER50	14 x 51	GK1EK
9	35	ATS490D22Y	ATS490D32Y	GV3L40	LC1D80●●	DF3FR80	22 x 58	GS1JD3
15	50	ATS490D32Y	ATS490D38Y	GV4L80B	LC1D65A●●	DF3FR80	22 x 58	GS1JD3
18.5	50	ATS490D38Y	ATS490D47Y	GV4L80B	LC1D80●●	DF3FR100	22 x 58	GS1JD3
22	50	ATS490D47Y	ATS490D62Y	GV4L115B	LC1D115●●	DF3FR100	22 x 58	GS1JD3
30	50	ATS490D62Y	ATS490D75Y	GV4L115B	LC1D115●●	DF400125	00	GS1KKD3
37	50	ATS490D75Y	ATS490D88Y	NSX160F MA	LC1D150●●	DF400125	00	GS1KKD3
45	50	ATS490D88Y	ATS490C11Y	NSX250F MA	LC1G185●●●●	DF400160	00	GS1LLD3
55	50	ATS490C11Y	ATS490C14Y	NSX250F MA	LC1G225●●●●	DF400160	00	–
75	50	ATS490C14Y	ATS490C17Y	NSX400F MicroLogic 1.3 M	LC1G265●●●●	DF430400	30	–
90	50	ATS490C17Y	ATS490C21Y	NSX400F MicroLogic 1.3 M	LC1G330●●●●	DF430400	30	–
110	50	ATS490C21Y	ATS490C25Y	NSX630F MicroLogic 1.3 M	LC1G400●●●●	–	–	–
132	50	ATS490C25Y	ATS490C32Y	NSX630F MicroLogic 1.3 M	LC1G500●●●●	DF431700	31	–
160	50	ATS490C32Y	ATS490C41Y	NS630bN MicroLogic 5.0 LR Off	LC1G630●●●●	DF431700	31	–
220	50	ATS490C41Y	ATS490C48Y	NS800N MicroLogic 5.0 LR Off	LC1G800●●●●	DF433800	33	–
250	85	ATS490C48Y	ATS490C59Y	NS1000N MicroLogic 5.0 LR Off	LC1F1000●●	–	–	–
355	85	ATS490C79Y	ATS490M10Y	NS1250N MicroLogic 5.0 LR Off	LC1F2600●● (3)	DF4441600	44	–

(1) Set I_{rm} current of the circuit breaker (when available) to a minimum of six times the current rating of the soft starter.

(2) Replace with the appropriate control circuit voltage code (refer to page 51).

(3) Type 2 coordination is only possible if the fast-acting fuses remain in the motor supply circuit and are not bypassed at the end of starting.

Altivar Soft Starter ATS490

Soft starters for asynchronous motors
Type 2 coordination according to IEC 60947-4-2
380/400/415 V power supply

380/400/415 V power supply, ATS490 connected in-line

Motor power kW	I _q (kA)	ATS490		Circuit breaker (1) Q1 reference	Optional line contactor KM1 reference	Fast-acting fuses with microswitch		Fuse disconnector Reference
		Class 10 Normal duty	Class 20 Heavy duty			FU reference	Size	
5.5	50	–	ATS490D17Y	GV2L20	LC1D25●●	DF3ER50	14 x 51	GK1EK
7.5	50	ATS490D17Y	ATS490D22Y	GV2L20	LC1D25●●	DF3ER50	14 x 51	GK1EK
11	40	ATS490D22Y	ATS490D32Y	GV2L22	LC1D25●●	DF3FR80	22 x 58	GS1JD3
15	40	ATS490D32Y	ATS490D38Y	GV2L32 + GV1L3	LC1D32●●	DF3FR80	22 x 58	GS1JD3
18.5	40	ATS490D38Y	ATS490D47Y	GV3L40	LC1D50A●●	DF3FR100	22 x 58	GS1JD3
22	40	ATS490D47Y	ATS490D62Y	GV3L50	LC1D50A●●	DF3FR100	22 x 58	GS1JD3
30	50	ATS490D62Y	ATS490D75Y	GV3L65	LC1D65A●●	DF400125	00	GS1KKD3
37	50	ATS490D75Y	ATS490D88Y	GV4L80N	LC1D80●●	DF400125	00	GS1KKD3
45	50	ATS490D88Y	ATS490C11Y	GV4L115N	LC1D115●●	DF400160	00	GS1LLD3
55	50	ATS490C11Y	ATS490C14Y	GV4L115N	LC1D115●●	DF400160	00	–
75	50	ATS490C14Y	ATS490C17Y	NSX160N MA	LC1D150●●	DF430400	30	–
90	50	ATS490C17Y	ATS490C21Y	NSX250N MA	LC1G185●●●●	DF430400	30	–
110	50	ATS490C21Y	ATS490C25Y	NSX250N MA	LC1G225●●●●	–	–	–
132	50	ATS490C25Y	ATS490C32Y	NSX400N MicroLogic 1.3 M	LC1G265●●●●	DF431700	31	–
160	50	ATS490C32Y	ATS490C41Y	NSX400N MicroLogic 1.3 M	LC1G330●●●●	DF431700	31	–
220	50	ATS490C41Y	ATS490C48Y	NSX630N MicroLogic 1.3 M	LC1G500●●●●	DF433800	33	–
250	50	ATS490C48Y	ATS490C59Y	NSX630N MicroLogic 1.3 M	LC1G500●●●●	–	–	–
315	50	ATS490C59Y	ATS490C66Y	NS630bN MicroLogic 5.0 LR Off	LC1G630●●●●	–	–	–
355	50	ATS490C66Y	ATS490C79Y	NS800N MicroLogic 5.0 LR Off	LC1G630●●●●	–	–	–
400	50	ATS490C79Y	ATS490M10Y	NS800N MicroLogic 5.0 LR Off	LC1G800●●●●	DF4441600	44	–
500	85	ATS490M10Y	ATS490M12Y	NS1000N MicroLogic 5.0 LR Off	LC1F1000●●	DF4442200	44	–
630	85	ATS490M12Y	–	NS1250N MicroLogic 5.0 LR Off	LC1F2600●● (3)	DF4442200	44	–

380/400/415 V power supply, ATS490 connected inside motor delta

Motor power kW	I _q (kA)	ATS490		Circuit breaker (1) Q1 reference	Optional line contactor KM1 reference	Fast-acting fuses with microswitch		Fuse disconnector Reference
		Class 10 Normal duty	Class 20 Heavy duty			FU reference	Size	
11	40	–	ATS490D17Y	GV2L22	LC1D25●●	DF3ER50	14 x 51	GK1EK
15	40	ATS490D17Y	ATS490D22Y	GV2L32 + GV1L3	LC1D32●●	DF3ER50	14 x 51	GK1EK
18.5	40	ATS490D22Y	ATS490D32Y	GV3L40	LC1D50A●●	DF3FR80	22 x 58	GS1JD3
22	40	ATS490D32Y	ATS490D38Y	GV3L50	LC1D50A●●	DF3FR80	22 x 58	GS1JD3
30	50	ATS490D38Y	ATS490D47Y	GV3L65	LC1D65A●●	DF3FR100	22 x 58	GS1JD3
45	50	ATS490D47Y	ATS490D62Y	GV4L115N	LC1D115●●	DF3FR100	22 x 58	GS1JD3
55	50	ATS490D62Y	ATS490D75Y	GV4L115N	LC1D115●●	DF400125	00	GS1KKD3
55	50	ATS490D75Y	ATS490D88Y	GV4L115N	LC1D115●●	DF400125	00	GS1KKD3
75	50	ATS490D88Y	ATS490C11Y	NSX160N MA	LC1D150●●	DF400160	00	GS1LLD3
90	50	ATS490C11Y	ATS490C14Y	NSX250N MA	LC1G185●●●●	DF400160	00	–
110	50	ATS490C14Y	ATS490C17Y	NSX250N MA	LC1G225●●●●	DF430400	30	–
132	50	ATS490C17Y	ATS490C21Y	NSX400N MicroLogic 1.3 M	LC1G265●●●●	DF430400	30	–
160	50	ATS490C21Y	ATS490C25Y	NSX400N MicroLogic 1.3 M	LC1G330●●●●	–	–	–
220	50	ATS490C25Y	ATS490C32Y	NSX630N MicroLogic 1.3 M	LC1G500●●●●	DF431700	31	–
250	50	ATS490C32Y	ATS490C41Y	NSX630N MicroLogic 1.3 M	LC1G500●●●●	DF431700	31	–
315	50	ATS490C41Y	ATS490C48Y	NS630bN MicroLogic 5.0 LR Off	LC1G630●●●●	DF433800	33	–
355	50	ATS490C48Y	ATS490C59Y	NS800N MicroLogic 5.0 LR Off	LC1G630●●●●	–	–	–
400	50	ATS490C59Y	ATS490C66Y	NS800N MicroLogic 5.0 LR Off	LC1G800●●●●	–	–	–
500	50	ATS490C66Y	ATS490C79Y	NS1000N MicroLogic 5.0 LR Off	LC1F1000●●	–	–	–
630	85	ATS490C79Y	ATS490M10Y	NS1250N MicroLogic 5.0 LR Off	LC1F2600●● (3)	DF4441600	44	–

(1) Set I_{rm} current of the circuit breaker (when available) to a minimum of six times the current rating of the soft starter.

(2) Replace with the appropriate control circuit voltage code (refer to page 51).

(3) Type 2 coordination is only possible if the fast-acting fuses remain in the motor supply circuit and are not bypassed at the end of starting.

440 V power supply, ATS490 connected in-line								
Motor power kW	I _q (kA)	ATS490		Circuit breaker (1) Q1 reference	Optional line contactor KM1 reference	Fast-acting fuses with microswitch		Fuse disconnecter Reference
		Class 10 Normal duty	Class 20 Heavy duty			FU reference	Size	
5.5	50	–	ATS490D17Y	GV4L25N	LC1D65A●●	DF3ER50	14 x 51	GK1EK
7.5	50	ATS490D17Y	ATS490D22Y	GV4L25N	LC1D65A●●	DF3ER50	14 x 51	GK1EK
11	20	ATS490D22Y	ATS490D32Y	GV4L25N	LC1D65A●●	DF3FR80	22 x 58	GS1JD3
15	20	ATS490D32Y	ATS490D38Y	GV4L50N	LC1D65A●●	DF3FR80	22 x 58	GS1JD3
18.5	20	ATS490D38Y	ATS490D47Y	GV4L50N	LC1D65A●●	DF3FR100	22 x 58	GS1JD3
22	20	ATS490D47Y	ATS490D62Y	GV4L50N	LC1D65A●●	DF3FR100	22 x 58	GS1JD3
30	50	ATS490D62Y	ATS490D75Y	GV4L80N	LC1D65A●●	DF400125	00	GS1KKD3
37	50	ATS490D75Y	ATS490D88Y	GV4L80N	LC1D65A●●	DF400125	00	GS1KKD3
45	40	ATS490D88Y	ATS490C11Y	GV4L80N	LC1D80●●	DF400160	00	GS1LLD3
55	40	ATS490C11Y	ATS490C14Y	GV4L115N	LC1D115●●	DF400160	00	–
75	50	ATS490C14Y	ATS490C17Y	NSX160N MA	LC1D150●●	DF430400	30	–
90	50	ATS490C17Y	ATS490C21Y	NSX250N MA	LC1G150●●●●	DF430400	30	–
110	50	ATS490C21Y	ATS490C25Y	NSX250N MA	LC1G185●●●●	–	–	–
132	50	ATS490C25Y	ATS490C32Y	NSX400 MA	LC1G225●●●●	DF431700	31	–
160	50	ATS490C32Y	ATS490C41Y	NSX400N MicroLogic 1.3 M	LC1G265●●●●	DF431700	31	–
220	50	ATS490C41Y	ATS490C48Y	NSX630H MicroLogic 1.3 M	LC1G400●●●●	DF433800	33	–
250	50	ATS490C48Y	ATS490C59Y	NSX630H MicroLogic 1.3 M	LC1G400●●●●	–	–	–
355	50	ATS490C59Y	ATS490C66Y	NS630bN MicroLogic 5.0 LR Off	LC1G630●●●●	–	–	–
400	50	ATS490C66Y	ATS490C79Y	NS800N MicroLogic 5.0 LR Off	LC1G630●●●●	–	–	–
500	50	ATS490C79Y	ATS490M10Y	NS800N MicroLogic 5.0 LR Off	LC1G800●●●●	DF4441600	44	–
630	85	ATS490M10Y	ATS490M12Y	NS1000N MicroLogic 5.0 LR Off	LC1F1000●●	DF4442200	44	–
710	85	ATS490M12Y	–	NS1250N MicroLogic 5.0 LR Off	LC1F2600●● (3)	DF4442200	44	–

500 V power supply, ATS490 connected in-line								
Motor power kW	I _q (kA)	ATS490		Circuit breaker (1) Q1 reference	Optional line contactor KM1 reference	Fast-acting fuses with microswitch		Fuse disconnecter Reference
		Class 10 Normal duty	Class 20 Heavy duty			FU reference	Size	
7.5	50	–	ATS490D17Y	GV2L20 + LA9LB920	LC1D25●●	DF3ER50	14 x 51	GK1EK
9	50	ATS490D17Y	ATS490D22Y	GV2L20 + LA9LB920	LC1D25●●	DF3ER50	14 x 51	GK1EK
11	20	ATS490D22Y	ATS490D32Y	GV2L20 + LA9LB920	LC1D25●●	DF3FR80	22 x 58	GS1JD3
18.5	20	ATS490D32Y	ATS490D38Y	GV2L32 + LA9LB920	LC1D32●●	DF3FR80	22 x 58	GS1JD3
22	20	ATS490D38Y	ATS490D47Y	NSX100H MA	LC1D80●●	DF3FR100	22 x 58	GS1JD3
30	20	ATS490D47Y	ATS490D62Y	NSX100H MA	LC1D80●●	DF3FR100	22 x 58	GS1JD3
37	50	ATS490D62Y	ATS490D75Y	NSX100H MA	LC1D150●●	DF400125	00	GS1KKD3
45	50	ATS490D75Y	ATS490D88Y	NSX100H MA	LC1D150●●	DF400125	00	GS1KKD3
55	40	ATS490D88Y	ATS490C11Y	NSX100H MA	LC1D150●●	DF400160	00	GS1LLD3
75	50	ATS490C11Y	ATS490C14Y	NSX160H MA	LC1D150●●	DF400160	00	–
90	50	ATS490C14Y	ATS490C17Y	NSX160H MA	LC1G185●●●●	DF430400	30	–
110	50	ATS490C17Y	ATS490C21Y	NSX160H MA	LC1G185●●●●	DF430400	30	–
132	50	ATS490C21Y	ATS490C25Y	NSX250H MA	LC1G225●●●●	–	–	–
160	50	ATS490C25Y	ATS490C32Y	NSX400H MicroLogic 1.3 M	LC1G265●●●●	DF431700	31	–
220	50	ATS490C32Y	ATS490C41Y	NSX400H MicroLogic 1.3 M	LC1G400●●●●	DF431700	31	–
250	40	ATS490C41Y	ATS490C48Y	NSX630H MicroLogic 1.3 M	LC1G400●●●●	DF433800	33	–
315	50	ATS490C48Y	ATS490C59Y	NSX630H MicroLogic 1.3 M	LC1G500●●●●	–	–	–
400	50	ATS490C59Y	ATS490C66Y	NS630bH MicroLogic 5.0 LR Off	LC1G800●●●●	–	–	–
450	50	ATS490C66Y	ATS490C79Y	NS800H MicroLogic 5.0 LR Off	LC1G800●●●●	–	–	–
500	50	ATS490C79Y	ATS490M10Y	NS800H MicroLogic 5.0 LR Off	LC1F1000●●	DF4441600	44	–
630	85	ATS490M10Y	ATS490M12Y	NS1000H MicroLogic 5.0 LR Off	LC1F2600●● (3)	DF4442200	44	–
800	85	ATS490M12Y	–	NS1250H MicroLogic 5.0 LR Off	LC1F2600●● (3)	DF4442200	44	–

(1) Set I_{rm} current of the circuit breaker (when available) to a minimum of six times the current rating of the soft starter.

(2) Replace with the appropriate control circuit voltage code (refer to page 51).

(3) Type 2 coordination is only possible if the fast-acting fuses remain in the motor supply circuit and are not bypassed at the end of starting.

690 V power supply, ATS490 connected in-line								
Motor power kW	I _q (kA)	ATS490		Circuit breaker (1) Q1 reference	Optional line contactor KM1 reference	Fast-acting fuses with microswitch		Fuse disconnecter Reference
		Class 10 Normal duty	Class 20 Heavy duty			FU reference	Size	
11	50	–	ATS490D17Y	NSX100HB1 MA	LC1D80●●	DF3ER50	14 x 51	GK1EK
15	50	ATS490D17Y	ATS490D22Y	NSX100HB1 MA	LC1D80●●	DF3ER50	14 x 51	GK1EK
18.5	20	ATS490D22Y	ATS490D32Y	NSX100HB1 MA	LC1D80●●	DF3FR80	22 x 58	GS1JD3
22	20	ATS490D32Y	ATS490D38Y	NSX100HB1 MA	LC1D80●●	DF3FR80	22 x 58	GS1JD3
30	20	ATS490D38Y	ATS490D47Y	NSX100HB1 MA	LC1D150●●	DF3FR100	22 x 58	GS1JD3
37	20	ATS490D47Y	ATS490D62Y	NSX100HB1 MA	LC1D150●●	DF3FR100	22 x 58	GS1JD3
45	25	ATS490D62Y	ATS490D75Y	NSX100HB1 MA	LC1D150●●	DF400125	00	GS1KKD3
55	25	ATS490D75Y	ATS490D88Y	NSX100HB1 MA	LC1D150●●	DF400125	00	GS1KKD3
75	40	ATS490D88Y	ATS490C11Y	NSX100HB1 MA	LC1D150●●	DF400160	00	GS1LLD3
90	50	ATS490C11Y	ATS490C14Y	NSX250HB1 MA	LC1G185●●●●	DF400160	00	–
110	50	ATS490C14Y	ATS490C17Y	NSX250HB1 MA	LC1G225●●●●	DF430400	30	–
160	50	ATS490C17Y	ATS490C21Y	NSX250HB1 MA	LC1G225●●●●	DF430400	30	–
200	50	ATS490C21Y	ATS490C25Y	NSX250HB1 MA	LC1G265●●●●	–	–	–
250	50	ATS490C25Y	ATS490C32Y	NSX400HB1 MicroLogic 1.3 M	LC1G330●●●●	DF431700	31	–
315	50	ATS490C32Y	ATS490C41Y	NSX630HB1 MicroLogic 1.3 M	LC1G400●●●●	DF431700	31	–
400	40	ATS490C41Y	ATS490C48Y	NSX630HB1 MicroLogic 1.3 M	LC1G630●●●●	DF433800	33	–
500	50	ATS490C48Y	ATS490C59Y	NS630bLB MicroLogic 5.0 LR Off	LC1G630●●●●	–	–	–
560	50	ATS490C59Y	ATS490C66Y	NS630bLB MicroLogic 5.0 LR Off	LC1G800●●●●	–	–	–
630	50	ATS490C66Y	ATS490C79Y	NS800LB MicroLogic 5.0 LR Off	LC1F2600●● (3)	–	–	–
710	50	ATS490C79Y	ATS490M10Y	NS800LB MicroLogic 5.0 LR Off	LC1F2600●● (3)	DF4441600	44	–
900	42	ATS490M10Y	ATS490M12Y	NS1000H MicroLogic 5.0 LR Off	LC1F2600●● (3)	DF4442200	44	–
950	42	ATS490M12Y	–	NS1250H MicroLogic 5.0 LR Off	LC1F2600●● (3)	DF4442200	44	–

(1) Set I_{rm} current of the circuit breaker (when available) to a minimum of six times the current rating of the soft starter.

(2) Replace with the appropriate control circuit voltage code (refer to page 51).

(3) Type 2 coordination is only possible if the fast-acting fuses remain in the motor supply circuit and are not bypassed at the end of starting.

Line contactor reference table														
Basic reference	Power supply	Control voltage code												
		24	42	48	110	115	220	230	240	380	400	415	440	500
LC1D18...D150 (1)	50/60 Hz	B7	D7	E7	F7	FE7	M7	P7	U7	Q7	V7	N7	R7	S7
LC1D18...D65 (2)	50 Hz	B5	D5	E5	-	-	-	P5	-	-	-	-	-	-
LC1D80...D115	50 Hz	B5	D5	E5	F5	FE5	M5	P5	U5	Q5	V5	N5	R5	S5
LC1D80...D115	60 Hz	B6	-	E6	F6	-	M6	-	U6	Q6	-	-	R6	-
	DC	12	24	36	48	60	72	110	125	220	250	440		
LC1D18...D38 (3)	U 0.7...1.25 Uc	JD	BD	CD	ED	ND	SD	FD	GD	MD	UD	RD		
LC1D40A...D65A (3)	U 0.75...1.25 Uc	JD	(5)	(5)	(5)	(5)	(5)	(5)	(5)	(5)	(5)	RD		
LC1D80...D95	U 0.85...1.1 Uc	JD	BD	CD	ED	ND	SD	FD	GD	MD	UD	RD		
	U 0.75...1.2 Uc	JW	BW	CW	EW	-	SW	FW	-	MW	-	-		
LC1D115...150 (4)	U 0.75...1.2 Uc	-	BD	-	ED	ND	SD	FD	GD	MD	UD	RD		
	DC (low consumption)	5	12	20	24	48	110	220	250					
LC1D18...D38 (3)	U 0.8...1.25 Uc	AL	JL	ZL	BL	EL	FL	ML	UL					
	AC/DC (low consumption)													
LC1D18...D150	See TeSys D Green, page B8/4 of the TeSys catalog													
	AC	24	48	110	115	120	208	220	230	240	380	400	415	440
LC1F1000...2600	40...400 Hz (coil LX1F)	-	-	F7	-	G7	-	M7	P7	U7	Q7	V7	N7	R7
	DC	24	48	110	125	220	230	250	400	440				
LC1F1000...2600	(coil LX4F)	-	-	FD	GD	MD	-	UD	-	RD				
	AC/DC	24...48		48...130		100...250		200...500						
LC1G150...G500		BEEA		EHEN		KUEN		LSEA						
LC1G630...G800		-		EHEN		KUEN		LSEA						

(1) D115 and D150 coils with built-in suppression as standard, by bidirectional peak limiting diode.
 (2) Not available with connection for lugs or bars.
 (3) Coils with integral suppression device fitted as standard, by bidirectional peak limiting diode.
 (4) Coil with built-in suppression device as standard.
 (5) For these coil voltages, choose from TeSys D Green contactors. Same product reference radical, just add BBE coil voltage code for 24 V DC, BNE for 24-60 V AC/DC, EHE for 48-130 V AC/DC, or KUE for 100-250 V AC/DC. Example: LC1D40ABBE.

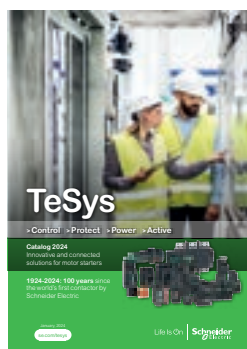

Altivar Soft Starter ATS490

Soft starters for asynchronous motors
Soft starters and line chokes

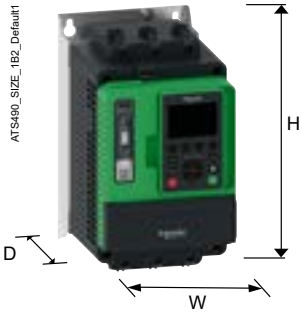

Soft starters		
Overall dimensions		
Reference	W x H x D	
	mm	in.
ATS490D17Y	160 x 283 x 185	6.3 x 11.14 x 7.28
ATS490D22Y	160 x 283 x 185	6.3 x 11.14 x 7.28
ATS490D32Y	160 x 289 x 234	6.3 x 11.38 x 9.21
ATS490D38Y	160 x 289 x 234	6.3 x 11.38 x 9.21
ATS490D47Y	160 x 289 x 234	6.3 x 11.38 x 9.21
ATS490D62Y	160 x 289 x 234	6.3 x 11.38 x 9.21
ATS490D75Y	160 x 289 x 234	6.3 x 11.38 x 9.21
ATS490D88Y	160 x 289 x 234	6.3 x 11.38 x 9.21
ATS490C11Y	160 x 289 x 234	6.3 x 11.38 x 9.21
ATS490C14Y	160 x 356 x 235	6.3 x 14.02 x 9.25
ATS490C17Y	160 x 356 x 235	6.3 x 14.02 x 9.25
ATS490C21Y	206 x 443 x 265	8.11 x 17.44 x 10.43
ATS490C25Y	206 x 443 x 265	8.11 x 17.44 x 10.43
ATS490C32Y	206 x 443 x 265	8.11 x 17.44 x 10.43
ATS490C41Y	304 x 455 x 300	11.97 x 17.91 x 11.81
ATS490C48Y	304 x 455 x 300	11.97 x 17.91 x 11.81
ATS490C59Y	304 x 455 x 300	11.97 x 17.91 x 11.81
ATS490C66Y	304 x 455 x 300	11.97 x 17.91 x 11.81
ATS490C79Y	436 x 580 x 350	17.17 x 22.83 x 13.78
ATS490M10Y	436 x 580 x 350	17.17 x 22.83 x 13.78
ATS490M12Y	436 x 580 x 350	17.17 x 22.83 x 13.78

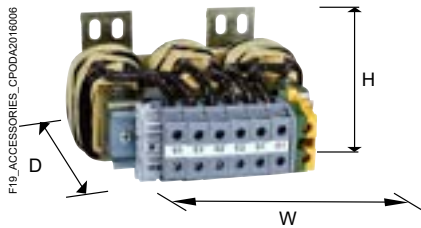

Line chokes		
Overall dimensions		
Reference	W x H x D	
	mm	in.
VZ1L015UM17T	130 x 155 x 80	5.12 x 6.1 x 3.15
VZ1L030U800T	155 x 170 x 120	6.10 x 6.69 x 4.72
VZ1L040U600T	175 x 200 x 130	6.89 x 7.87 x 5.12
VZ1L070U350T	180 x 200 x 150	7.09 x 7.87 x 5.91
VZ1L150U170T	270 x 234 x 147	10.63 x 9.21 x 5.79
VZ1L250U100T	270 x 237 x 190	10.63 x 9.33 x 7.48
VZ1L325U075T	300 x 260 x 206	11.81 x 10.24 x 8.11
VZ1L530U045T	380 x 415 x 225	14.96 x 16.34 x 8.86
VZ1LM10U024T	455 x 420 x 300	17.91 x 16.54 x 11.81
VZ1LM14U016T	400 x 490 x 330	15.75 x 19.29 x 12.99

Variable speed drives and soft starters

A whole world of Services for your drives and soft starters by Schneider Electric



Support and services offer by Schneider Electric

Variable speed drives and soft starters are an important part of your operation, with downtime having a significant impact on your business. Protecting that investment through comprehensive services means that you can continue to deliver optimally throughout the lifecycle of your drive and soft starter. Our range of services is designed to help you get more out of your drives and soft starters, your operation, and to improve your environmental impact.

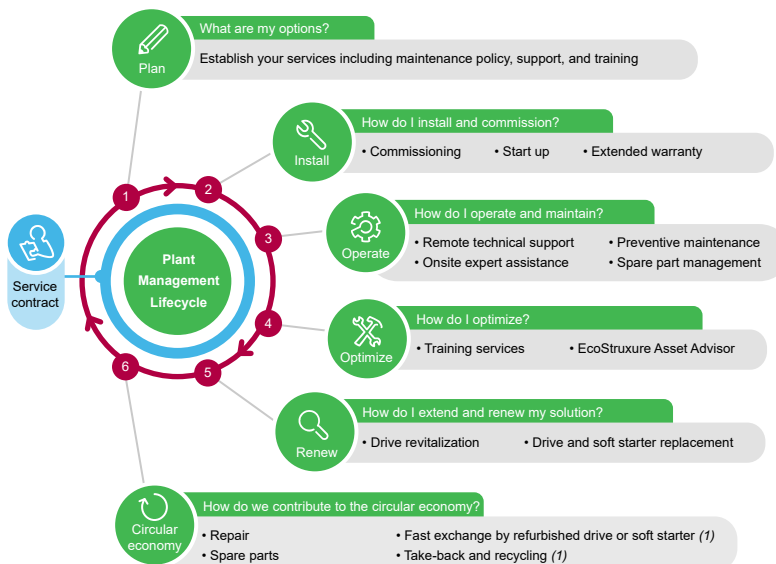

Install

- **Extended Warranty** service helps you control your maintenance costs. Schneider Electric will provide a replacement drive and soft starter or repair the product on site during a period of one or three years more than the standard warranty, in all conditions covered by the extended warranty.
- **Start-up** service is the first essential step in maintenance and optimal operational performance of the drive or soft starter. Our comprehensive review checks up to 100 parameters and is especially designed for drives and soft starters in simple applications.
- **Commissioning** service ensures a reliable start for operations with more complex applications and drive systems. The unique requirements of your process need to be carefully considered to ensure efficient operations.

Operate

- **Preventive Maintenance** service performs predetermined maintenance actions according to a product-specific schedule. The work is carried out by certified technical experts following Schneider Electric instructions. This service minimizes unplanned downtime and extends your equipment lifetime.
- **Remote Technical Support** brings you expert product assistance over the phone, email, chat, or web for any technical questions relating to your drives and soft starters, including configuration, diagnostics, and maintenance. Our global support team is multi-lingual with support available up to R&D level experts if needed.
- **On-Site Expert Assistance** service offers you highly skilled field service experts to troubleshoot and resolve drive or soft starter equipment-related matters at your site, as a back-up source of expertise for your personnel.
- **Spare Part Management** service identifies and manages your critical spare parts either on your site or offsite. This service ensures that you have access to the spares you need without having to invest in capital to maintain the stock.

(1) Services available in countries that have the right structure and capabilities.

Variable speed drives and soft starters

A whole world of Services for your drives and soft starters by Schneider Electric



Support and services offer by Schneider Electric (continued)

Optimize

- **Training** service offers eLearning, classroom, and onsite training provision to enhance the technical installation, commissioning, and maintenance competencies of your personnel. Added competence translates into further process efficiency and reliability, as well as employee satisfaction.
- **EcoStruxure Asset Advisor** service enables you to move from reactive to predictive maintenance and access actionable insight provided by the advisor. The service predicts drive- and motor-related actions through connected devices and advanced algorithms monitored by Schneider Electric's experts.

Renew

- **Drive Revitalization** is an excellent choice if you prefer to use your aging drives longer and want to extend their service life with affordable and comprehensive inspection and replacement of all critical parts.
- **Drive and soft starter replacement** involves modernizing equipment by replacing the previous aged or obsolete product with a new one matched to the purpose. The service can be extended with engineering in case the device and process requires more advanced engineering.

Circular economy

- **Spare Parts** are available from our local, regional, and global stocks. Original equipment parts from Schneider Electric are reliable and easily available. They will help to keep your product in operation for longer.
- **Repair** allows you to extend the life of your drive or soft starter. The affected product can be replaced, or repaired on site or at our repair centers, depending on the type of product in question.
- **Fast Exchange by refurbished drive or soft starter (1)** gives a second life to inoperative drives or soft starters. In this case, we offer an immediate exchange with a replacement refurbished drive or soft starter and take back the product, repair it, and keep it ready for the next exchange.
- **Take-back and recycling (1)** is the last step to improve your environmental impact. Unrepairable products are dismantled, raw materials are collected and given a second life. Up to 85% of the product components can be recycled.

Service contracts secure recovery, availability, and outcome

Service contracts manage the safety and performance of your assets through well-defined maintenance plans tailored to your operational needs. The predefined service contract – Advantage Service Plan – and fully customizable “à la carte” service contract are built from the services in the “Operate” and “Optimize” phases and service levels defining availability, response, and lead times matching your particular needs. You will enjoy priority access to Schneider Electric support when you need it, as well as having an expert partner to plan the long-term evolution of your drives and soft starters.

mySchneider app

With the mySchneider app you have easy 24/7 access to product information and expert support. All registered users have access to additional features, such as real-time notifications, order tracking, product pricing, and availability. The mySchneider app is available for download from the IOS and Android app store.

Schneider Electric – helping you succeed

Schneider Electric, the leader in digital transformation of energy management and automation, has operations in more than 100 countries. With this global footprint we have certified field service representatives, regional expert and advanced level support up to product R&D to provide you the right support across the lifecycle of your drives and soft starters. Furthermore, we offer an extensive network of local and global repair centers and a logistics chain that underpins our ability to respond to your needs.

To order services or find out more, please contact your local Schneider Electric service center.

(1) Services available in countries that have the right structure and capabilities.

#			
490NTC00005	36	DF4441600	47
490NTW00002	36		48
	40		49
			50
490NTW00002U	36	DF4442200	47
	40		48
			49
			50
490NTW00005	36		
	40	G	
490NTW00005U	36	GK1EK	47
	40		48
			49
			50
490NTW00012	36	GS1JD3	47
	40		48
			49
			50
490NTW00012U	36	GS1KGD3	47
	40		48
			49
			50
A		GS1LLD3	47
ATS490C11Y	25		48
ATS490C14Y	25		49
ATS490C17Y	25		50
ATS490C21Y	25	GS1LLD3	47
ATS490C25Y	25		48
ATS490C32Y	25		49
ATS490C41Y	25		50
ATS490C48Y	25	GV1L3	47
ATS490C59Y	25		48
ATS490C66Y	25	GV2L20	43
ATS490C79Y	25		44
ATS490D17Y	25		47
ATS490D22Y	25		48
ATS490D32Y	25	GV2L22	43
ATS490D38Y	25		44
ATS490D47Y	25		47
ATS490D62Y	25		48
ATS490D75Y	25	GV2L32	43
ATS490D88Y	25		44
ATS490M10Y	25		47
ATS490M12Y	25	GV3L40	43
D			44
DF3ER50	47		47
	48		48
	49	GV3L50	48
	50	GV3L65	43
DF3FR100	47		44
	48		47
	49		48
	50	GV4L115B	43
DF3FR80	47		47
	48	GV4L115N	45
	49		48
	50		49
DF400125	47	GV4L25N	45
	48		49
	49	GV4L50N	45
	50		49
DF400160	47	GV4L80B	43
	48		47
	49	GV4L80N	44
	50		45
DF430400	47		48
	48		49
	49	L	
	50	LA9LB920	49
DF431700	47	LU9AD7	38
	48	LU9GC3	30
	49		36
	50	T	
DF433800	47	TCSCAR013M120	37
	48	TCSCAR01NM120	38
	49	TCSMCNAM3M002P	40
	50	TCSXCNAMUM3P	30
		TSXCANCA100	37
		TSXCANCA300	37
		TSXCANCA50	37
		TSXCANCADD03	38
		TSXCANCADD1	38
		TSXCANCB100	37
		TSXCANCB300	37
		TSXCANCB50	37
		TSXCANCBDD3	38
		TSXCANCBDD5	38
		TSXCANCD100	37
		TSXCANCD300	37
		TSXCANCD50	37
		TSXCANKCDF180T	37
		TSXCANTDM4	38
		V	
		VW3A1104R10	30
		VW3A1104R100	30
		VW3A1104R30	30
		VW3A1104R50	30
		VW3A1105	40
		VW3A1111	29
		VW3A1112	30
		VW3A3607	38
		VW3A3608	37
		VW3A3618	37
		VW3A3628	38
		VW3A8127	40
		VW3A8306R	36
		VW3A8306R03	30
			36
		VW3A8306R10	30
			36
		VW3A8306R30	30
			36
		VW3A8306RC	30
			36
		VW3A8306TF03	30
			36
		VW3A8306TF10	30
			36
		VW3CANCARR03	37
		VW3CANCARR1	37
		VW3CANTAP2	37
		VW3G4701	41
		VW3G4702	41
		VW3G4703	41
		VX4G4901	28
		VZ1L015UM17T	41
		VZ1L030U800T	41
		VZ1L040U600T	41
		VZ1L070U350T	41
		VZ1L150U170T	41
		VZ1L250U100T	41
		VZ1L325U075T	41
		VZ1L530U045T	41
		VZ1LM10U024T	41
		VZ1LM14U016T	41
		VZ3V4902	28
		VZ3V4903	28
		VZ3V4904	28
		Z	
		ZB5AZ905	30

Legal information

The information provided in this Catalog contains description of Schneider Electric products, solutions and services ("Offer") with technical specifications and technical characteristics of the performance of the corresponding Offer.

The content of this document is subject to revision at any time without notice due to continued progress in methodology, design and manufacturing.

To the extent permitted by applicable law, no responsibility or liability is assumed by Schneider Electric and its subsidiaries for any type of damages arising out of or in connection with (i) informational content of this Catalog not conforming with or exceeding the technical specifications, or (ii) any error contained in this Catalog, or (iii) any use, decision, act or omission made or taken on basis of or in reliance on any information contained or referred to in this Catalog.

SCHNEIDER ELECTRIC MAKES NO WARRANTY OR REPRESENTATION OF ANY KIND, WHETHER EXPRESS OR IMPLIED, AS TO WHETHER THIS CATALOG OR ANY INFORMATION CONTAINED THEREIN SUCH AS PRODUCTS AND SERVICES WILL MEET REQUIREMENTS, EXPECTATIONS OR PURPOSE OF ANY PERSON MAKING USE THEREOF.

Schneider Electric brand and any trademarks of Schneider Electric and its subsidiaries referred to in this Catalog are property of Schneider Electric or its subsidiaries. All other brands are trademarks of their respective owners.

This Catalog and its content are protected under applicable copyright laws and provided for informative use only. No part of this Catalog may be reproduced or transmitted in any form or by any means (electronic, mechanical, photocopying, recording, or otherwise), for any purpose, without the prior written permission of Schneider Electric.

Copyright, intellectual, and all other proprietary rights in the content of this Catalog (including but not limited to software, audio, video, text, and photographs) rests with Schneider Electric or its licensors. All rights in such content not expressly granted herein are reserved. No rights of any kind are licensed or assigned or shall otherwise pass to persons accessing this information.

Life Is On



Learn more about our products at www.se.com

The information provided in this documentation contains general descriptions and/or technical characteristics of the performance of the products contained herein. This documentation is not intended as a substitute for and is not to be used for determining suitability or reliability of these products for specific user applications. It is the duty of any such user or integrator to perform the appropriate and complete risk analysis, evaluation and testing of the products with respect to the relevant specific application or use thereof. Neither Schneider Electric nor any of its affiliates or subsidiaries shall be responsible or liable for misuse of the information contained herein.

Design: Schneider Electric
Photos: Schneider Electric

Schneider Electric Industries SAS

Head Office
35, rue Joseph Monier - CS 30323
F-92500 Rueil-Malmaison Cedex
France

DIA2ED2240603EN
December 2024 - V1.0